

## Contents

---

<b>Overview of the Land Valuation Process</b> .....	<b>6</b>
Role of the Assessing Official.....	6
Representative Parcels.....	6
Representative Disclosure Statements.....	7
Land Value Ratio.....	7
Neighborhoods.....	7
Maps.....	8
Base Rates and Base Lots.....	8
Maximum Allowable Percentage Variance.....	8
Influence Factors.....	9
Establishing Land Value Maps.....	9
Evaluating Sales Information.....	12
Selecting Unit Values Used for Land Valuation...	13
Valuing Improved Vacant Platted Lots.....	16
Assessment of Rights-of-Way to Adjacent Property Holder.....	16
<b>Providing General Information on Property     Record Card</b> .....	<b>17</b>
Task 1- Recording Identification and Classification Data.....	17
Task 2-Recording the Site Characteristics.....	23
<b>Valuing Platted Lots</b> .....	<b>25</b>
Establishing Base Rates for Platted Lots.....	25
Establishing the Effective Frontage and Depth of Platted Lots.....	27
Determining Depth Factors for Platted Lots.....	38
Determining Influence Factors for Platted Lots.....	43
Completing the Land Data and Computations Section of the Property Record Card for Platted Lots.....	45
Task 1-Recording the Necessary Data.....	45
Task 2-Calculating the Land Value .....	48

<b>Valuing Residential Acreage and Agricultural Homesites.....</b>	<b>51</b>
Valuing Residential Acreage Parcels Larger Than One Acre.....	52
Valuing Residential Acreage Parcels One Acre or Smaller.....	52
Valuing Residential Acreage Tracts Using the Front Foot Method.....	53
Establishing Base Rates for Residential Acreage Tracts.....	53
Determining Size Adjustment Factors for Acreage.....	54
Determining Influence Factors for Residential Acreage.....	55
Completing the Land Data and Computations Section of Property Record Card for Residential Acreage.....	57
Task 1-Recording the Necessary Data.....	57
Task 2-Calculating the Land Value.....	59
<b>Valuing Commercial and Industrial Acreage....</b>	<b>62</b>
Understanding Commercial and Industrial Land Categories.....	62
Establishing Use Classes for Commercial and Industrial Properties.....	64
Determining the Building Density Ratio.....	64
Establishing Base Rates for Commercial and Industrial Land.....	66
Determining Influence Factors for Commercial and Industrial Land.....	67
Completing the Land Data and Computations Portion of Property Record Card for Commercial and Industrial Acreage.....	68
Task 1-Recording the Necessary Data.....	68
Task 2-Calculating the True Tax Value.....	71
<b>Valuing Agricultural Land.....</b>	<b>72</b>
<b>Agricultural Land Base Rate.....</b>	<b>73</b>
Assessing Agricultural Land.....	74

Converting Units of Measurement for Agricultural Land.....	81
Classifying Agricultural Land into Use Types.....	82
Using Soil Maps.....	90
Soil Series.....	90
Soil Map Units .....	91
Soil Complexes.....	91
Understanding the Calculation of the Soil Productivity Index.....	92
Valuing Strip Mined Agricultural Land.....	93
Valuation of Oil and Gas Interests .....	93
Completing the Land Data and Computations Section of Property Record Card for Agricultural Acreage.....	93
Task 1-Determining the Land Value for the Land areas.....	94
Task 2-Calculating the Total Farmland acreage.....	98
Task 3-Calculating the Value of Farmland.....	99
Task 4-Calculating the Value of Classified Land.....	100
Task 5-Calculating the Total Farmland/Classified Land Value.....	100
Task 6-Calculating the Land Value of the Homesite(s) and Agriculture Excess Acres.....	100
Completing the Valuation Record Section of the Property Record Card.....	101

### **Tables**

---

Table 2-1. Class Codes.....	19
Table 2-2. Subclass Codes.....	19
Table 2-3. Topography Options.....	23
Table 2-4. Street or Road Options.....	24
Table 2-5. Neighborhood Options.....	24

Table 2-6. Lot Depth Tables (100 and 120 Feet Standard Depth).....	41
Table 2-7. Lot Depth Tables (132 and 150 Feet Standard Depth).....	42
Table 2-8. Lot Depth Tables (175 and 200 Feet Standard Depth).....	43
Table 2-9. Land Type Options for Platted Lots.....	46
Table 2-10. Influence Factor Codes for Platted Lots.....	47
Table 2-11. Acreage Size Adjustment Table.....	55
Table 2-12. Land Type Options for Residential Acreage Tracts.....	57
Table 2-13. Influence Factor Codes for Residential Acreage and Agricultural Homesites.....	58
Table 2-14. Categories of Commercial and Industrial Land.....	62
Table 2-15. Recommended Unit Values for Selected Use Classes.....	64
Table 2-16. Land Type Options for Commercial and Industrial Acreage Tracts.....	68
Table 2-17. Influence Factor Codes for Commercial and Industrial Property.....	69
Table 2-18. Agricultural Land Value.....	74
Table 2-19. Agricultural Land Measurement Equivalencies.....	82
Table 2-20. Classified Land Subtypes.....	83
Table 2-21. Tillable Land Subtypes.....	87
Table 2-22. Other Farmland Subtypes.....	89
Table 2-23. Agricultural Support Land Subtypes.....	90
Table 2-24. Agricultural Land Use Types.....	95
Table 2-25. Influence Factors for Agricultural Acreage.....	96

**Figures**

---

Figure 2-1. Example of a 100% Platted Lot..... 28

Figure 2-2. Example of a Type 2 Platted Lot..... 29

Figure 2-3. Example of a Type 3 Platted Lot..... 30

Figure 2-4. Example of a Type 4 Platted Lot..... 31

Figure 2-5. Example of a Type 5 Platted Lot..... 32

Figure 2-6. Example of a Type 6 Platted Lot..... 32

Figure 2-7. Example of a Type 7 Platted Lot..... 33

Figure 2-8. Example of a Type 8 Platted Lot..... 34

Figure 2-9. Example of a Type 9 Platted Lot..... 35

Figure 2-10. Example of a Type 10 Platted Lot... 36

Figure 2-11. Example of a Type 11 Platted Lot... 37

Figure 2-12. Example of a Type 12 Platted Lot... 38

Figure 2-13. Dimensions of Example Lots..... 50

Figure 2-14. Example of Agricultural Land  
Measurements..... 81

Figure 2-15. Valuation Record Section of the  
Agricultural Property Record Card..... 102

Figure 2-16. Valuation Record Section of the  
Residential Property Record Card..... 104

Figure 2-17. Valuation Record Section of the  
Commercial and Industrial Property Record  
Card..... 106

## **Overview of the Land Valuation Process**

This section describes how each type of land is valued. It discusses how the assessing official determines base rates for the following types of land:

- platted lots
- residential acreage and agricultural homesites
- commercial and industrial acreage.

In addition, this section describes how the assessing official applies the base rates to determine the true tax land value for each of the types of land listed above, as well as for agricultural acreage.

### **Role of the Assessing Official**

The assessing official shall determine the value of all classes of residential land, commercial land, industrial land, and agricultural homesite within his or her jurisdiction. The established value of this land represents the January 1st market value of improved land.

The following list does not apply to this section:

- (1) land assessed as land devoted to agricultural use under IC 6-1.1-4-13;
- (2) land classified as forest land under IC 6-1.1-6;
- (3) land classified as a windbreak under IC 6-1.1-6.2; or
- (4) land classified as a filter strip under IC 6-1.1-6.7.

The following guidelines shall be followed in determining land valuations.

### **Representative Parcels**

The assessing official must select a representative number of sales disclosure statements filed under IC 6-1.1-5.5 or written estimations of a property value provided by a licensed real estate professional that are based on relevant sales data to justify the land value determination for each neighborhood. All sales disclosure statements must be verified by:

- (1) a visual inspection of the subject property; and
- (2) a reasonable attempt to determine that the transaction was negotiated as an arm's-length transaction.

All sales disclosure statements selected must be adjusted to exclude the value of any personal property of significant value that was included in the disclosed sales price. All sales disclosure statements selected involving property that is not typical of the neighborhood must be adjusted to negate the affect the atypical aspects of the property have on the disclosed sales price.

For the purposes of this section, a “representative number” shall mean a number that is no less than three percent (3%) of the total number of parcels within the neighborhood established under the section headed “neighborhood.”

- (1) a lesser percentage is truly representative of values in the neighborhood; or
- (2) disclosure statements from a substantially similar neighborhood are truly representative of values in the neighborhood.

Assessing officials should select disclosure statements or estimations of value that, based on all relevant facts and evaluation of the neighborhood as a whole, fairly represent the value of property in the neighborhood.

### **Representative Disclosure Statements**

Representative disclosure statements selected for use must refer to a transaction, or written estimations of value must refer to an estimation of value, that is dated no more than eighteen (18) months prior or subsequent to January 1st. Valuation adjustments may be made based on the date of the disclosure statement or estimations of value. Valuation adjustments should be made as is necessary to approximate the value of the subject land on January 1st.

### **Land Value Ratio**

The assessing official must determine an appropriate land value ratio to be applied to sales disclosure statements or estimations of value of improved properties. This ratio must take into account factors that are critical to determination of the value of the land. The ratio and factors must be included as part of the land value determination. The factors should include, but not be limited to, such factors as:

- (1) unimproved lot sale prices designated by property developers;
- (2) the desirability due to physical features, such as waterfront property or wooded lots;
- (3) the desirability of the location due to external features, such as school district or proximity to commercial developments; and
- (4) consideration of the replacement cost of the improvement.

### **Neighborhoods**

All property within a jurisdiction must be established as part of a neighborhood defined by the assessing official. The assessing official shall define neighborhoods according to:

- (1) common development characteristics;
- (2) the average age of the majority of improvements;
- (3) the size of lots or tracts;
- (4) subdivision plats and zoning maps;

- (5) school and other taxing district boundaries;
- (6) distinctive geographic boundaries;
- (7) any manmade improvements that significantly disrupt the cohesion of adjacent properties;
- (8) sales statistics; and
- (9) other characteristics deemed appropriate to assure equitable determinations.

### **Maps**

All neighborhoods must be identified on easily read maps. The maps must be numerically organized, clearly delineate the neighborhood boundary, show the neighborhood established base rate and the code number. All neighborhoods shall be assigned a code number for identification. A copy of the maps shall be readily available for public inspection.

All property record cards must give the:

- (1) number of the map on which the neighborhood that includes the subject property is shown;
- (2) neighborhood code number; and
- (3) applicable base rate.

### **Base Rates and Base Lots**

The assessing official shall establish a base rate for pricing each neighborhood. Base rates should include a specifically stated value for water supply, sewage disposal, and all other on-site development costs. Neighborhoods shall be classified according to majority use as residential, agricultural homesite, commercial, or industrial. The assessing official shall also establish a base lot to represent the typical and average characteristics of lots in the neighborhood for the purpose of making pricing adjustments.

### **Maximum Allowable Percentage Variance**

The assessing official shall establish a maximum allowable percentage variance between the base lot value for neighborhoods having the same classification and substantially similar characteristics. The maximum allowable percentage variance should not exceed twenty percent (20%). (If ranges are established, the maximum allowable percentage variance should be applied to compare the two (2) highest rates to each other and the two (2) lowest rates to each other.) If adjacent neighborhoods located on opposite sides of a jurisdiction or county boundary:

- (1) have the same classification and substantially similar characteristics; and
- (2) the variance between the neighborhood base lot values is greater than the maximum allowable percentage variance established by either jurisdiction;



For the purposes of this section, “substantially similar characteristics” refers to characteristics that are predominant in, and common to, each neighborhood, and in all material respects are substantially similar in terms of:

- (1) the size and shape of lots or tracts;
- (2) the age and style of improvements;
- (3) the condition and quality of improvements;
- (4) zoning;
- (5) the general use of improvements;
- (6) development conditions;
- (7) infrastructure components;
- (8) geographic features;
- (9) proximity to primary traffic routes;
- (10) governmental services; and
- (11) neighborhood desirability, as reflected by market values.

### **Influence Factors**

In addition to the provisions of this chapter, the assessing official shall establish detailed criteria relating to influence factors that may be applied to individual parcels. The criteria relating to influence factors shall include:

- (1) criteria for identifying and determining the existence of unique features that are inconsistent with the norm for the neighborhood;
- (2) specific conditions that will be considered as evidence that a parcel deserves an influence factor;
- (3) a method for evaluating whether a particular condition actually influences the value of the parcel; and
- (4) any factors, criteria, or conditions relating to influence factors that are promulgated in a rule by the Department.

### **Establishing Land Value Maps**

Each assessing official must obtain copies of maps pertaining to the various areas of the jurisdiction. These maps must be plat maps or recorded plats that have been reproduced from the county’s plat mapping system. The maps are necessary to indicate the developed portions of a jurisdiction. The maps should indicate the outlines of the blocks, streets, roads, and alleys, and include the lots and their dimensions. Some organizational ideas for planning the mapping obligation for this function are:

- In a smaller, less populated jurisdiction the number of maps necessary to complete the task of compiling the land value maps could be relatively small. A master jurisdiction map might be included with copies of separate plat map pages for the areas of the jurisdiction which are considered more developed.

These developed areas could be a small town or a variety of different platted subdivisions sprinkled throughout the jurisdiction.

- In a medium sized jurisdiction the number of maps increases because the mixture of developed properties increases. A general jurisdiction map would be beneficial to use as an index location system, but the main working maps should be reproduced using each section as the base. Each developed area of the section would have a separate map of the area as recorded in the plat books.
- In a large jurisdiction the map requirements would be limited to the parameters of the existing county system. Normally, these jurisdictions have a sophisticated system in place that identifies a specific portion of the jurisdictions by plat page. The maps necessary to complete the land value map obligation would be at the plat page level.

Many assessing officials begin the land valuation process by first recording the current values on the working copy of the maps. This process develops a picture of the values and their current neighborhood boundaries. These neighborhood boundaries may change as the assessing official analyzes the changing characteristics of established neighborhoods and identifies the developing areas within the jurisdiction. Preliminary neighborhood boundaries may be sketched onto the working boundaries at this time to reflect the assessing official's initial impression of the values within the jurisdiction.

The assessing official can begin the task of analyzing sales information to determine the market value of the land as of January 1st. Sales information of individual properties is derived from sales disclosure forms. These forms are filed with the county at the time a property exchanges hands and a copy for each form has been retained for each transaction since July 1, 1997. The sales disclosure forms should be organized and filed by property location and property class. An analysis of the grouped sales as compared with their map location could influence the assessing official to redraw the preliminary neighborhood boundaries. The objective of this comparison is to refine each neighborhood into a market value range for similar type properties. Each specific neighborhood shall be identified on reproducible maps and have an assigned code number unique to the area.

Once the sales have been grouped, an analysis of the neighborhood is made to determine the land value ratio. This ratio is expressed as a percentage and represents the amount of a sale attributable to the land. The mechanics for determining this ratio are further explained under the *Allocation Method* in the Section *Evaluating Sales Information*. It is advisable that the assessing official start in the areas of the jurisdiction which are clearly of a greater value and analyze the reasons why these values are higher. Once these reasons become apparent, the assessing official can use the distinguishing features as a basis for the further analysis of the entire jurisdiction. This process is necessary because each designated neighborhood within the jurisdiction shall have a land value ratio.

A visual inspection and verification process is required on a representative sample of properties included in each sales grouping. By reviewing the sales disclosures for each neighborhood, the assessing official can select properties for inspection that represent the typical property for the neighborhood. The sales transaction of property should be free of any unique circumstances that would suggest the stated purchase price is not representative of the neighborhood. The visual inspection is necessary to make sure that the assessing official understands the physical aspects of the property at the time of sale. A copy of the property record card, as of the sale date, would serve as the best comparison method. If there are necessary questions raised during the inspection, the assessing official should contact the buyer of the property to ensure that the correct information is captured. The visual inspection of the property also gives the assessing official the opportunity to compare the characteristics of the subject neighborhood against the characteristics of various other neighborhoods.

Each identified neighborhood shall have a representative sample of sales to establish the land value. The representative sample is defined in this section as three percent (3%) of the total number of parcels within the neighborhood. If the number of sales disclosures for the neighborhood is less than the required three percent (3%), the assessing official must contact a local licensed real estate professional about providing a letter of opinion on the value of various parcels located throughout the neighborhood as of January 1st.

The most important issue to consider next is the assessing official's task of establishing the market value for residential, commercial, industrial, and agricultural homesite land as of January 1st. The pricing method and base rate are mathematical functions to arrive at this desired value. As a source of value comparison between neighborhoods, the assessing official shall designate a base lot for each specific neighborhood throughout the jurisdiction. The base lot represents the typical and average characteristics of lots located within the neighborhood. For a homogeneous neighborhood that contains only subdivided lots of 60' x 132', the designated base lot is 60' x 132'. The base lot for a neighborhood comprised of agricultural parcels only is a one (1) acre homesite.

A maximum value variance between substantially similar neighborhoods with the same classification shall not exceed twenty percent (20%). The assessing official shall establish a maximum allowable variance of twenty percent (20%) or less.

Sales disclosure documents and real estate broker's letters of opinion can next be analyzed to determine the actual value of the subject neighborhoods. By applying the established land value ratio to the sales information, the assessing official can determine the amount of sale attributable to land. The value for each sale is compared against the remaining neighborhood sales to determine the appropriate value for the neighborhood. As this comparison is performed for each

neighborhood, a final analysis of the neighborhood boundaries is warranted to ensure that the boundaries are correct on each map.

With the neighborhood boundaries finalized and the maps completed with the recorded values, the assessing official can begin the task of calculating the base rates applicable to each neighborhood.

### **Evaluating Sales Information**

When establishing land values throughout the jurisdiction, each assessing official shall evaluate sales information by using the sales comparison method, the abstraction method, or the allocation method. Each method is described below.

The *sales comparison method* is one of the most reliable methods of estimating land value. Under this method, the sale prices of similar properties are compared. The greater the number of sales, the more reliable the results. Sales prices might require adjustment to account for differences in the properties compared. Sale prices may be adjusted by a percentage or a specific dollar amount basis. The assessing official should research every market area and base adjustments on measurable market differences in properties. Examples of the adjustment process using the sales comparison method are provided below.

**Example 1:** A vacant parcel sold for \$10,200 in early 2009. The parcel slopes sharply from the street. The developer of the subdivision reports that the parcel sold at a discount of \$3,000 to cover the cost of correcting the problem. To make the sale representative of other vacant land in the area, add the amount of the discount to the sales price ( $\$10,200 + \$3,000 = \$13,200$ ). The cost of the discount added to the land selling price is equal to the true land value.

**Example 2:** A vacant parcel sold for \$10,000 on contract. Information obtained from the real estate broker indicates that the buyer was related to the developer and obtained a 15% discount on the sale. The value of the unimproved lot is 85% of the adjusted sale price. To adjust for the discount, find the sale price without the discount ( $\$10,000 \div .85 = \$11,765$ ). The cost to improve the land is added to the vacant land price to equal an improved land value.

The *abstraction method* is used to determine the indicated value of residential land if the sample of vacant land sales is insufficient for a geographic area. This method of estimating land value is most reliable when a minimum amount of depreciation has occurred on the improvements. The value of land is determined by subtracting the depreciated value of the improvements from the sales price. The result indicates the contribution of the land value to the total sale. An example of the abstraction method is provided below.

**Example 3:** A residential property sold for \$59,500 in January 2009. If the depreciated value of the structures equals \$50,300, the indicated value of the improved land is \$9,200 ( $\$59,500 - \$50,300 = \$9,200$ ).

The *allocation* or *percentage of sale* method is used to determine the indicated value of land if the sample of sales for a neighborhood represents improved properties. This method of estimating land values depends on an analysis of the various neighborhoods to determine the percentage contribution of land to the total sale.

Compare the sale price of vacant land to the sale price of the improved parcels within a homogeneous neighborhood. The resulting ratio is equal to the allocation percentage of sale for the neighborhood. However, before the comparison can be made, adjust the vacant lot sale upward to account for improvements such as utility hook-ups, landscaping, residential driveways, and private walkways. This adjustment is necessary because these appurtenances to the land are valued with the land. Also, the amount of improvement can be expressed as a percentage of the total land value. In the following example, the amount is expressed as a whole dollar development cost.

**Example 4:** Suppose a vacant land sale for neighborhood #501 is \$20,000 and the applicable development costs are \$5,000 in January, 2009. Determine an estimate of the applicable percentage ratio by comparing the \$25,000 developed land value to the recent neighborhood #501 sale prices of improved properties. For example, if improved properties are selling for \$125,000 to \$135,000, the estimated percentage of sale range for neighborhood #501 is 18.5% to 20%. The value of a standard lot in neighborhood #501 would be estimated at \$25,000. If a neighborhood has no vacant parcels to help determine a developed lot value, the assessing official must begin the process of comparing the subject neighborhood to neighborhoods where the percentage of sale is known. Comparable neighborhoods consist of neighborhoods with similar sale prices and neighborhood characteristics. Once a comparable neighborhood has been established, the percentage of sale ratio is multiplied against the selling prices of the improved parcels to arrive at an estimated land value for the subject neighborhood.

### **Selecting Unit Values Used for Land Valuation**

Unit values or base rates are units of measurement used in the assessment calculation process. The assessing official determines which of the following five types of unit values, described in the sections below, are appropriate for valuing the different types of land in the jurisdiction:

- front foot value
- square foot value
- acreage value
- site value
- unit density

The size, dimensional data available on tax maps or plat maps, methods of comparison used by the typical buyer and seller, and the ease of application should determine the selection of the most applicable pricing method for the

neighborhood. It should be stressed that the pricing method for valuing the neighborhood is of less importance than arriving at the correct value of the land as of the valuation date.

### *Front Foot Value*

Front foot value is a whole dollar amount applied to the most desirable frontage of a parcel. For commercial property in a downtown area, front footage along the main street is of primary importance. For a residential parcel in a platted subdivision, front footage along the street is of primary importance. In both cases, the front foot method is appropriate because the front footage of the parcel has the greatest influence on the land's value. Front foot value is the appropriate method when the selling price of similar properties, divided by the amount of frontage is similar. The following example illustrates the relationship between front foot value and selling price.

**Example:** Parcel A has 100 feet of frontage on Main Street and Parcel B has 50 feet of frontage on Main Street. Both parcels have the same depth. Parcel A sold for \$12,000. Parcel B sold for \$6,000. To calculate the base rate, divide the sale price of the parcel by the frontage feet:

$$\text{Parcel A } \$12,000 \div 100' = \$120$$

$$\text{Parcel B } \$6,000 \div 50' = \$120$$

In both cases, the selling price divided by the number of frontage feet equals \$120 per front foot. Because the same base rate is obtained on both properties, the assessing official determines that the front foot method is the appropriate land valuation method for these properties.

### *Square Foot Value*

Square foot value is a value applied to each individual square foot of a parcel. The square foot method is used when the selling price divided by the area in square feet for similar properties is similar. The following example illustrates how to use the selling price to determine square foot value.

**Example:** Parcels C and D both have 100 feet of frontage on Oak Street. Parcel C is 200 feet deep, has an area of 20,000 square feet, and sold for \$10,000. Parcel D is 100 feet deep, has an area of 10,000 square feet and sold for \$5,000. Calculate the square foot value by dividing the sale price of the parcel by the area of the parcel in square feet:

$$\text{Parcel C } \$10,000 \div 20,000 = \$0.50$$

$$\text{Parcel D } \$5,000 \div 10,000 = \$0.50$$

Because the same base rate (\$0.50 per square foot) is obtained for both properties, the assessing official determines that the square foot method is the appropriate method for these properties. The front foot value method is not appropriate because the front foot value method produces a front foot value for Parcel C that is twice the front foot value for Parcel D.

### *Acreage Value*

The acreage value method is appropriate where a particular use requires a large amount of land. The most frequent uses of the acreage value method are for:

- agricultural homesites
- rural residential homesites
- rural residential excess acreage
- commercial and industrial land
- irregularly shaped platted lots that are too cumbersome to size.

### *Site Value*

The site value method is applied when characteristics peculiar to a particular parcel distort the value determined using other methods. This value distortion is normally attributed to the parcel's shape or size. The following example illustrates the use of the site value method.

**Example:** In a neighborhood the standard lot is 50 feet by 120 feet, with a calculated front foot price of \$100. The typical lot sells for \$5,000. However, Lot #20 is an irregularly shaped lot with dimensions that make it extremely difficult to determine lot size and price. The value estimate for Lot #20 is similar to all other lots in the area, so the site value estimate is recorded at a flat rate of \$5,000. In this example the \$5,000 site value is equivalent to the base lot value, indicating that in the assessing official's judgment the irregularity of the subject's shape neither enhances nor detracts from the value of the subject in respect to the base lot value.

- Suppose that the irregularity of the subject's shape **enhanced** the value of the subject by 10%. The resulting true tax value for the subject is \$5,500 ( $\$5,000 + 10\%$ ).
- Suppose that the irregularity of the subject's shape **decreased** the value of the subject by 10%. However, the decrement was off-set by the subject's premium location. In this instance the base lot value of the subject neighborhood decreased. The resulting true tax value for the subject lot is \$5,000 ( $\$5,000 = 10\% - 10\%$ ).
- **Note:** In all cases the starting point is the base lot value of the subject neighborhood, and the treatment of that value as an "estimated value".

### *Unit Density*

Unit density is a value applied to the number of units which can be constructed on a site. It is used when the market indicates that a site is sold on a unit basis, such as an apartment property where the unit of comparison is sale price per buildable apartment.

### Valuing Improved Vacant Platted Lots

Platted lots are valued on the basis of improvements made to them. Improvements to the land include, but are not limited to, the cost of:

- a water well
- a septic system
- connecting a structure into a public water and sewage system
- landscaping
- private walkways and residential driveways

The assessing official must survey the jurisdiction to determine the costs of these improvements for each neighborhood as of January 1st. The cost attributable to a water and sewage system should represent depreciated costs of not less than 50% of the total installation cost of each component.

The improved land value estimate represents the cost of vacant land, plus the depreciated cost of a water well and septic system or public utility hook-up fees plus any costs, such as landscaping and private walkways and residential driveways incurred to make the parcel suitable for building. An example of estimating the land value for an individual land sale is provided below.

**Example:** An 80 feet by 150 feet commercial platted vacant lot was purchased for \$30,000. The water well and septic system cost for this particular area is \$5,500. The depreciated cost of the water well and septic system is calculated as:  $(.80 \times \$5,500) = \$4,400$ . The assessor knows that the water well and septic system are relatively new, so the 80% ratio is used. The landscaping cost associated with the parcel is estimated to be \$10,000. The cost of the vacant land plus the depreciated cost of the water well and septic system and landscaping attributable to the land equals the value of the improved vacant lot  $(\$30,000 + \$4,400 + \$10,000 = \$44,400)$ .

### Assessment of Rights-of-Way to Adjacent Property Holder

Land may not be assessed to an adjacent property holder if it is:

- occupied by, and is within the right-of-way of, a railroad, interurban, or street railway
- within the line of a levee constructed and maintained either by a levee association or under any law of this state
- used and occupied as part of a public drainage ditch, including land that:
  - is adjacent to the ditch
  - cannot be used for farmland or any other purpose because of a need for access to the ditch
- within a right-of-way that is used and occupied as a public highway.



If the land has not been transferred by deed to a person who holds the land for railroad, interurban, street railway, levee, drainage, or public highway purposes, the land is assessed to the adjacent property owner. However, the assessed value of the land so assessed is deducted from the assessed value of the land assessed to the adjacent property owner. If an assessing official and a landowner fail to agree on the amount of land assessed, the county surveyor must survey the land in question.

## **Providing General Information on the Property Record Card**

---

Before you provide the information and perform the calculations necessary to value a property, you need to identify the parcel and provide general information about it. The front of the residential, agricultural, and commercial and industrial Property Record Cards provide specific areas for recording information about the parcel's:

- identity
- location
- classification
- ownership
- site characteristics

The steps for recording this information are grouped into the following tasks, described in the sections below:

- Task 1—Record identification and classification data for the parcel.
- Task 2—Record the site characteristics of the parcel.

### **Task 1—Recording Identification and Classification Data**

To record identification and classification data for the parcel, perform these steps:

- STEP 1** In the “Parcel number” cell, enter the parcel number used for taxation purposes.
- STEP 2** In the “County” cell, enter the county number where the parcel is located.
- STEP 3** In the “Jurisdiction” cell, enter the Department of Local Government Finance’s assigned number for the jurisdiction where the parcel is located.
- STEP 4** *If the parcel is located in a corporation*, enter the Department of Local Government Finance’s assigned number for the corporation in the “Corporation” cell.

- STEP 5** In the “district cell, enter the Department of Local Government Finance’s assigned taxing district number for the location of the subject parcel.
- STEP 6** In the “Section and Plat” cell, enter the county code that represents the specific mapped area of the district where the parcel is located. Letters or numbers may be used.
- STEP 7** In the “Routing Number” cell, enter the assigned number that matches the parcel’s location on a specific map. This number facilitates field inspection.

**NOTE:** If there is more than one property card for the parcel, enter the same routing number on each card.

- STEP 8** In the “Neighborhood Code Number” cell, enter the code number assigned by the jurisdiction assessor to the parcel’s location.
- STEP 9** “Property Class” is an index to identify the class of property for each individual parcel. Enter a one-digit code for the general property class, and a two-digit suffix code for the subclass.

The basis for classification is the predominant current use. All contiguous parcels associated with the main use designation should be coded with the same property subclass codes.

**Example:** A parcel used for a bank parking lot should have the same property class code of 444 as the parcel containing the bank building. All associated parcel numbers should be listed in a computer accessible memorandum section of the Property Record Card for the main or highest valued parcel. The parcel number of the main or highest valued parcel should likewise be identified on each of the associated parcels. If a parcel is unused, the basis for classification depends on the anticipated use or the use for which the parcel is zoned. When entering the general property class, note that the property class applies to the entire parcel. Therefore, for multiple card parcels, it is necessary to enter the class only on the card numbered “001”.

*Table 2-1* shows the general property class codes. *Table 2-2* shows the two-digit subclass codes that fall within each property class.

### Property Class Codes

The following table shows the general property class codes. The second table shows the two-digit subclass codes that fall within each property class.

**Table 2-1. Class Codes**

This option	Indicates
1	Agricultural taxable land and improvements used primarily for agricultural purposes
2	The legal description is being valued for severed mineral rights at a flat value of sixty dollars (\$60) per acre
3	Industrial taxable land and improvements used primarily for manufacturing, processing, or refining foods and materials
4	Commercial taxable land and improvements used for general commercial and recreational purposes
5	Residential taxable land and improvements used primarily for residential purposes
6	Exempt property
8	Taxable land and improvements owned by a public utility company

**Table 2-2. Subclass Codes**

<b>Class Code 1</b> Agricultural taxable land and improvements used primarily for agricultural purposes			
<b>100</b> Vacant land	<b>104</b> Poultry farm	<b>110</b> Hog farm	<b>149</b> Agricultural land with personal property mobile home
<b>101</b> Cash grain/general farm	<b>105</b> Fruit & nut farm	<b>111</b> Beef farm	<b>198</b> Structure on leased land
<b>102</b> Livestock other than dairy and poultry	<b>106</b> Vegetable farm	<b>120</b> Timber	<b>199</b> Other agricultural use
<b>103</b> Dairy farm	<b>107</b> Tobacco farm	<b>141</b> Agricultural land with mobile home	
	<b>108</b> Nursery		
	<b>109</b> Greenhouses		
<b>Class Code 2</b> The legal description is being valued for severed mineral rights at a flat value of sixty dollars (\$60) per acre			
<b>200</b> Severed mineral rights			
<b>Class Code 3</b> Industrial taxable land and improvements used primarily for manufacturing, processing, or refining foods and materials			
<b>300</b> Vacant land	<b>330</b> Medium manufacturing and assembly	<b>346</b> Research and development facility	<b>370</b> Small shops
<b>309</b> Parcel classified as vacant but is part of the support land for another parcel	<b>340</b> Light manufacturing and assembly	<b>350</b> Industrial warehouse	<b>380</b> Mines or quarries
<b>310</b> Food and drink processing facility	<b>345</b> Industrial office	<b>360</b> Industrial truck terminal	<b>385</b> Landfill
<b>320</b> Foundries and heavy manufacturing			<b>390</b> Grain elevator
			<b>398</b> Structure on leased land
			<b>399</b> Other industrial structure

<b>Class Code 4 Commercial taxable land &amp; improvements used for general commercial &amp; recreational purposes</b>			
<b>400</b> Vacant land	<b>422</b> Discount and junior department stores	<b>443</b> Drive-up/walk-up bank only	<b>461</b> Drive-in theaters
<b>401</b> 4 to 19 family apartments	<b>424</b> Full line department stores	<b>444</b> Full service banks	<b>462</b> Golf range or miniature course
<b>402</b> 20 to 39 family apartments	<b>425</b> Neighborhood shopping center (Strip center)	<b>445</b> Savings and loans	<b>463</b> Golf course
<b>403</b> 40 or more family apartments	<b>426</b> Community shopping center	<b>447</b> Office building (1 or 2 story)	<b>464</b> Bowling alley
<b>409</b> Parcel classified as vacant but is part of the support land for another structure	<b>427</b> Regional shopping center	<b>448</b> Office building (O/T 47 walk-up)	<b>465</b> Lodge hall
<b>410</b> Motels or tourist cabins	<b>428</b> Convenience market	<b>449</b> Office building (O/T 47 elevator)	<b>466</b> Amusement park
<b>411</b> Hotels	<b>429</b> Other retail structures	<b>450</b> Convenience market with gasoline sales	<b>467</b> Health club
<b>412</b> Nursing homes and private hospitals	<b>430</b> Restaurant, café, or bar	<b>451</b> Convenience market / franchise-type restaurant with gasoline sales	<b>468</b> Ice rink
<b>415</b> Mobile home parks	<b>431</b> Franchise-type restaurant	<b>452</b> Auto service station	<b>469</b> Riverboat gaming resort
<b>416</b> Commercial camp grounds	<b>435</b> Drive-in restaurant	<b>453</b> Car washes	<b>480</b> Commercial warehouse
<b>419</b> Other commercial housing	<b>439</b> Other food service	<b>454</b> Auto sales and service	<b>481</b> Commercial mini-warehouse
<b>420</b> Small detached retail of less than 10,000 square feet	<b>440</b> Dry clean plant or laundry	<b>455</b> Commercial garage	<b>482</b> Commercial truck terminals
<b>421</b> Supermarkets	<b>441</b> Funeral home	<b>456</b> Parking lot or structure	<b>490</b> Marine service facility
	<b>442</b> Medical clinics or offices	<b>460</b> Theaters	<b>495</b> Marina
			<b>496</b> Marina – small boats
			<b>498</b> Structure on leased land
			<b>499</b> Other commercial structures
<b>Class Code 5 Residential taxable land and improvements used primarily for residential purposes</b>			
<b>500</b> Vacant platted lot	<b>511</b> One family dwelling on unplatted land of 0 to 9.99 acres	<b>521</b> Two family dwelling on unplatted land of 0 to 9.99 acres	<b>531</b> Three family dwelling on unplatted land of 0 to 9.99 acres
<b>501</b> Vacant unplatted land of 0 to 9.99 acres	<b>512</b> One family dwelling on unplatted land of 10 to 19.99 acres	<b>522</b> Two family dwelling on unplatted land of 10 to 19.99 acres	<b>532</b> Three family dwelling on unplatted land of 10 to 19.99 acres
<b>502</b> Vacant unplatted land of 10 to 19.99 acres	<b>513</b> One family dwelling on unplatted land of 20 to 29.99 acres	<b>523</b> Two family dwelling on unplatted land of 20 to 29.99 acres	<b>533</b> Three family dwelling on unplatted land of 20 to 29.99 acres
<b>503</b> Vacant unplatted land of 20 to 29.99 acres	<b>514</b> One family dwelling on unplatted land of 30 to 39.99 acres	<b>524</b> Two family dwelling on unplatted land of 30 or 39.99 acres	<b>534</b> Three family dwelling on unplatted land of 30 to 39.99 acres
<b>504</b> Vacant unplatted land of 30 to 39.99 acres	<b>515</b> One family dwelling on unplatted land of 40 or more acres	<b>525</b> Two family dwelling on unplatted land of 40 or more acres	<b>535</b> Three family dwelling on unplatted land of 40 or more acres
<b>505</b> Vacant unplatted land of 40 or more acres	<b>520</b> Two family dwelling on a platted lot	<b>530</b> Three family dwelling on a platted lot	<b>540</b> Mobile or manufactured home on a platted lot
<b>509</b> Parcel classified as vacant but is part of the support land for another parcel			
<b>510</b> One family dwelling on platted lot			

Continued on next page

<b>Class Code 5</b> <i>continued</i>			
<b>541</b> Mobile or manufactured home on unplatted land of 0 to 9.99 acres	<b>545</b> Mobile or manufactured home on unplatted land of 40 or more acres	<b>554</b> Condominium unit on unplatted land of 30 to 39.99 acres	<b>591</b> Personal property mobile or manufactured home on unplatted land
<b>542</b> Mobile or manufactured home on unplatted land of 10 to 19.99 acres	<b>550</b> Condominium unit on a platted lot	<b>555</b> Condominium unit on unplatted land of 40 or more acres	<b>598</b> Structure on leased land
<b>543</b> Mobile or manufactured home on unplatted land of 20 to 29.99 acres	<b>551</b> Condominium unit on unplatted land of 0 to 9.99 acres	<b>556</b> Condominium dwelling (row type)	<b>599</b> Other residential structures
<b>544</b> Mobile or manufactured home on unplatted land of 30 to 39.99 acres	<b>552</b> Condominium unit on unplatted land of 10 to 19.99 acres	<b>557</b> Condominium common areas	
	<b>553</b> Condominium unit on unplatted land of 20 to 29.99 acres	<b>558</b> Condominium master card	
		<b>590</b> Personal property mobile or manufactured home on platted property	
<b>Class Code 6</b> Exempt property			
<b>600</b> Exempt property owned by the United States of America	<b>640</b> Exempt property owned by a municipality	<b>665</b> Exempt property owned by a public library	<b>686</b> Church, chapel, mosque, synagogue, tabernacle, or temple that is granted an exemption
<b>610</b> Exempt property owned by the State of Indiana	<b>645</b> Exempt property owned by a municipal housing authority	<b>669</b> Other exempt property owned by a governmental unit	<b>690</b> Exempt property owned by a cemetery organization that is granted an exemption
<b>620</b> Exempt property owned by a county	<b>650</b> Exempt property owned by a board of education	<b>670</b> Exempt property owned by a private academy or college	<b>699</b> Other exempt property owned by an organization that is granted an exemption
<b>621</b> Exempt property certified for treasurer's sale	<b>660</b> Exempt property owned by a park district	<b>680</b> Exempt property owned by a charitable organization that is granted an exemption	
<b>622</b> Exempt property held for resale	<b>661</b> Exempt property owned by a conservancy district	<b>685</b> Exempt property owned by a religious organization that is granted an exemption	
<b>630</b> Exempt property owned by a township	<b>662</b> Exempt property owned by a sanitary district		

<b>Class Code 8</b> Taxable land and improvements owned by a public utility company			
<b>800</b> Locally assessed vacant utility land-commercial	<b>825</b> Locally assessed property owned by a light, heat, or power company-industrial	<b>845</b> Locally assessed property owned by a railroad company-industrial	<b>861</b> State assessed property owned by a telephone, telegraph, or cable company that constitutes a part of any right-of-way of the distribution system
<b>805</b> Locally assessed vacant utility land-industrial	<b>830</b> Locally assessed property owned by a pipeline company-commercial	<b>850</b> Locally assessed property owned by a sewage company-commercial	<b>865</b> Locally assessed property owned by a telephone, telegraph, or cable company-industrial
<b>810</b> Locally assessed property owned by a bus company-commercial	<b>831</b> State assessed property owned by a pipeline company that constitutes a part of any right-of-way of the distribution system	<b>851</b> State assessed property owned by a sewage company that constitutes a part of any right-of-way of the collection system	<b>870</b> Locally assessed property owned by a water distribution company-commercial
<b>811</b> State assessed property owned by a bus company	<b>835</b> Locally assessed property owned by a pipeline company-industrial	<b>855</b> Locally assessed property owned by a sewage company-industrial	<b>871</b> State assessed property owned by a water distribution company that constitutes a part of any right-of-way of the distribution system
<b>815</b> Locally assessed property owned by a bus company-industrial	<b>840</b> Locally assessed property owned by a railroad company-commercial	<b>860</b> Locally assessed property owned by a telephone, telegraph, or cable company-commercial	<b>875</b> Locally assessed property owned by a water distribution company-industrial
<b>820</b> Locally assessed property owned by a light, heat, or power company-commercial	<b>841</b> State assessed operating property owned by a railroad company		
<b>821</b> State assessed property owned by a light, heat, or power company that constitutes part of any right-of-way of the light, heat, or power company			

NOTE: Under class code 8, subclass codes 21, 31, 41, 51, 61, and 71 have a zero value at the local level.

**STEP 10** In the “Property Address” cell, enter the street address of the parcel (not the parcel’s legal description).

NOTE: You must enter or correct the address in the field.

**STEP 11** In the left blank of the “Card No.” cell, enter the number for the Property Record Card. For example, if this card is the first card for the parcel, enter 001, if it is the second card, enter 002, and so forth.

NOTE: When you have completed all of the Property Record Cards for the parcel, enter the total number of cards in the right blank of the “Card No.” cell. For example, the third card of four cards is labeled “Card No. 003 of 004.”

**STEP 12** In the “Transfer of Ownership” section, record ownership information that is subsequent to the ownerships preprinted on the Property Record Card. Record information about each grantee and transfer in a separate row:

- a. In the “Date” column, enter the date of the parcel transfer.
- b. In the “Grantee” column, enter the name and address of the party to whom the parcel was transferred.
- c. In the “Sale Price” column, enter the sale price as indicated on the Sales Disclosure Form.
- d. In the “Owner Occupied” column, on the agricultural or residential property record card, place a check in the “Yes” box if owner occupied, or place a check in the “No” box if not owner occupied.

### **Task 2—Recording the Site Characteristics**

To record the parcel’s general site characteristics, perform these steps:

- STEP 1** In the “Topography” section, place a check in the check boxes for the terms that describe the terrain of the site in terms of its suitability for use. *Table 2-3* describes the topography options.

**Table 2-3. Topography Options**

<b>This option</b>	<b>Indicates a site</b>
Level	Approximately at street level and relatively flat.
Level and High	Higher than street level, but relatively flat and otherwise appearing suitable for use with minimal extraordinary site preparation.
High	Higher than street level and sloping enough to require extraordinary site preparation. Undeveloped land checked “High” may require a value adjustment. Improved land may require a value adjustment depending on the extent to which the detriment to value remains.
Low	Lower than street level and sloping enough to require extraordinary site preparation.
High and Low	Exhibiting both “High” and “Low” characteristics.
Rolling	With undulating terrain that may require extraordinary site preparation, depending on the use of the site.
Swampy	Subject to holding water and not readily drainable. If this condition applies to a portion of the parcel, insert “p” (for part) instead of a check, and place checks in the check boxes that describe the rest of the site.

- STEP 2** In the “Public Utilities” section, place a check in the check boxes for the site services provided by public utility companies and governmental

jurisdictions, such as water, sewer, gas and electricity. Follow these guidelines:

- Place a check in the check boxes for each of the services provided, whether or not the service is being used.
- If all of the utilities are available, place a check in the “All” check box instead of checking the individual items.

**STEP 3** In the “Street or Rd.” section, place a check in the check boxes for the characteristics of the primary fronting street or road, or the street or road that provides the most immediate access. *Table 2-4* describes the street or road options.

**Table 2-4. Street or Road Options**

<b>This option</b>	<b>Indicates</b>
Paved	A concrete, blacktop, or comparably improved street or road
Unpaved	A dirt or comparably unimproved street or road
Proposed	A street or road does not exist, but is planned and approved for the future
Sidewalk	The parcel is served by a paved sidewalk available for public use
Alley	The parcel is served by an alley

**STEP 4** In the “Neighborhood” section, place a check in the check box for the option that best describes the life cycle stage most characteristic of the neighborhood where the parcel is located. *Table 2-5* describes the neighborhood options.

**Table 2-5. Neighborhood Options**

<b>This option</b>	<b>Indicates</b>
Improving	A stage of development evidenced by increasing desirability
Static	A condition of equilibrium evidenced by little change
Declining	A stage of disintegration evidenced by decreasing desirability
Blighted	A marked decline characterized by structural deterioration and environmental deficiencies



## Valuing Platted Lots

This section describes how to value platted lots. Before you can value platted lots, you need to understand the following topics, which are addressed in this section:

- how the assessing official establishes base rates for platted lots
- how to establish the effective frontage and depth for a platted lot
- how to determine the depth factor for a platted lot
- how to determine any influence factors for a platted lot.

### Establishing Base Rates for Platted Lots

Using the neighborhood information contained on the land value maps, the assessing official calculates the indicated front foot values for each platted lot in a neighborhood by performing the steps below:

- STEP 1** Determine the value of the lot from the analyzed information on the map.
- STEP 2** Determine the depth factor for the lot. Instructions are provided in the section “*Determining Depth Factors for Platted Lots*” in this chapter.
- STEP 3** To determine the adjusted value, divide the value of the lot (determined in Step 1) by the depth factor for the lot (determined in Step 2):

$$\text{Adjusted value} = \text{Lot value} \div \text{Depth factor}$$

- STEP 4** Determine the effective front footage of the lot. Instructions are provided in the section *Establishing the Effective Frontage and Depth of Platted Lots* in this chapter.
- STEP 5** To obtain the indicated front foot value for the lot, divide the adjusted value (obtained in Step 3) by the effective front footage of the lot (determined in Step 4):

$$\text{Indicated front foot value} = \text{Adjusted value} \div \text{Effective front footage}$$

The assessing official then uses the indicated front foot values calculated for the lots in a neighborhood to determine the base rate per front foot for the area. The following examples illustrate how to calculate and analyze indicated front foot values. As you review these examples, keep in mind that the process of determining front foot values and base rates often is not exact. It is exact only when the selling price is known. By analyzing sales disclosure forms and estimations of value from the neighborhood, the assessor can determine a 2011 land value estimate to use.

**Example 1:** Neighborhood #1 is platted with all lots measuring 60 feet by 120 feet. Since the standard depth for the area is 120 feet, the depth factor is 1.00. The estimates from the sales data sheet indicate that the value for an improved lot is approximately \$6,000. The calculation for the indicated front foot value is:

$$\$6,000 \div 1.00 = \$6,000 \div 60' = \$100.$$

Because all of the lots in this neighborhood are the same, the base rate in Neighborhood #1 is \$100 per front foot.

**Example 2:** Neighborhood #2 has a mixture of various sized lots with the typical lot identified as 60 feet by 150 feet. The standard depth is 150 feet, and the assessor has determined the base lot value to be \$9,000.

- Lot #1 measures 60 feet by 150 feet. Therefore, its depth factor is 1.00. It is valued at \$9,000. Its indicated front foot rate is:

$$\$9,000 \div 1.00 = \$9,000 \div 60' = \$150$$

- Lot #12 measures 70 feet by 160 feet. Its depth factor is 1.03. It is valued at \$10,200. Its indicated front foot rate is:

$$\$10,200 \div 1.03 = \$9,903 \div 70' = \$141.47$$

- Lot #23 measures 80 feet by 200 feet. Its depth factor is 1.11. It is valued at \$12,200. Its indicated front foot rate is:

$$\$12,200 \div 1.11 = \$10,991 \div 80' = \$137.39$$

In Neighborhood #2, the range of values is somewhat narrow. The assessing official's first obligation is to establish a base value and rate for the typical lot. In this example, the typical lot is 60 feet by 150 feet, with a base lot value of \$9,000 and an indicated base rate of \$150. This base rate is the rate that should be established for Neighborhood #2. The lots that are different from the base lot should be analyzed for specific influence factors. The criteria necessary to identify specific influence factors should be determined by assessing official.

**Example 3:** Overlook Valley is a platted subdivision with some lots on a bluff overlooking a lake. Other lots are not on the lake. During the analysis of recent sales, the assessor finds three distinct land value areas within the subdivision. Lot #1 through Lot #25 overlook the lake and have an analyzed land value of \$60,000. Lot #26 through Lot #56 are located across the street from the lake lots and have an analyzed land value of \$35,000. Lot #57 through Lot #80 are located nearest the state highway and have an analyzed land value of \$20,000. The typical lot size in the subdivision is 100 feet by 120 feet. However, Lot #1 through Lot #25 are 80 feet by 175 feet.

The assessing official has decided that the difference in base lot size and base lot value is significant and warrants the division of the subdivision into two separate neighborhoods. Lot #1 through Lot #25 are designated as Neighborhood #3. Lot #26 through Lot #80 are designated as Neighborhood #4.

- Neighborhood #3 has a base lot size of 80 feet by 175 feet. The standard lot for the area is 175 feet and the depth factor is 1.00. The indicated front foot rate is:

$$\$60,000 \div 1.00 = \$60,000 \div 80' = \$750.00.$$

- Neighborhood #4 has a base lot size of 100 feet by 120 feet. The analyzed land values of the neighborhood range from \$35,000 to \$20,000. The depth factor for Neighborhood #4 is 1.00. For Lot # 26 through Lot #56 with lots valued at \$35,000, the indicated front foot rate is:

$$\$35,000 \div 1.00 = \$35,000 \div 100' = \$350.00.$$

- For Lot #57 through Lot #80 with lots valued at \$20,000, the indicated front foot rate is:

$$\$20,000 \div 1.00 = \$20,000 \div 100' = \$200.00.$$

In this example, the assessor developed a range of base rates for Neighborhood #4—\$200 for the low rate and \$350 for the high rate.

### **Establishing the Effective Frontage and Depth of Platted Lots**

The front foot method is the method generally used to value platted lots. When determining a lot's size using the front foot method, the following criteria must be met:

- Prior to establishing the size of the lot, the scale of the plat must be established.
- The effective frontage and depth must form right angles.
- The depth lines must be parallel to each other.
- The frontage line must be perpendicular to the depth lines.

Of course, actual lots do not necessarily meet these criteria. This section discusses how to calculate the effective frontage and effective depth of actual lots in order to calculate land value using the front foot method. Sample lot shapes are shown to help guide you. When you calculate the effective frontage and depth for an irregularly shaped lot, you should show your calculations on the property record card or an attachment.

**TYPE 1 LOT**

The Type 1 lot is known as a 100% lot. The characteristics of a 100% lot are:

- The vertical lines of the lot form right angles with the horizontal lines of the lot.
- There are no lines in the lot that do not form a 90° angle.
- The narrowest portion of this type of lot is usually the frontage.

**Example:** The lot shown below has an actual frontage of 50 feet, an effective frontage of 50 feet, and an effective depth of 100 feet.

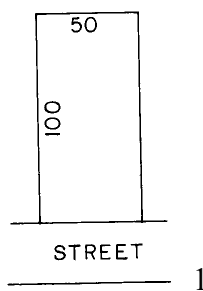

**Figure 2-1. Example of a 100% Platted Lot**

**TYPE 2 LOT**

The Type 2 lot is similar to a 100% lot, except that the rear line of the lot is not perpendicular to the depth lines. The actual and effective frontage are the same. To determine the effective depth of this type of lot, perform the following steps:

**STEP 1** Add the length of the two sides.

**STEP 2** Divide the total by two to determine the average depth.

**Example:** The lot shown below has an actual frontage of 50 feet, an effective frontage of 50 feet, and an effective depth of 117 feet ( $100' + 134' = 234' \div 2 = 117'$ ).

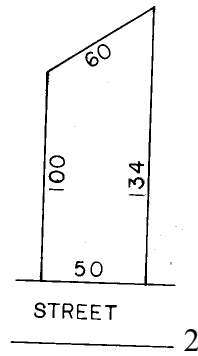

Figure 2-2. Example of a Type 2 Platted Lot

### TYPE 3 LOT

For the Type 3 lot, the frontage is the line that is perpendicular to the depth lines. For this type of lot, you must draw additional lines (shown as dashed lines in the example) to establish an accurate effective depth. Use of the 100 foot side line as the depth fails to account for the rear portion of the lot. Therefore, you must draw an additional depth line (the dashed line perpendicular to the frontage).

To find the effective depth of the lot, perform the following steps:

- STEP 1** Calculate the average depth of each section.
- STEP 2** Calculate the width percentage of each section to the total width of the lot.
- STEP 3** Multiply the width percentage for each section calculated in Step 2 by the average length of each section.
- STEP 4** Add the results for each section calculated in Step 3 to determine the weighted average length of the subject lot.

**Example:** The lot shown in below demonstrates how to draw additional depth lines. In this case only one additional depth line is necessary. The lot has an actual frontage of 70 feet (two sections of 35 feet), an effective frontage of 70 feet (two sections of 35 feet), and an effective depth of 120 feet.

$$\text{Average depth Section 1} = 100' + 140' = 240' \div 2 = 120'$$

$$\text{Average depth Section 2} = 100' + 140' = 240' \div 2 = 120'$$

$$\text{Width \% Section 1} = 35' \div 70' = .5 \text{ or } 50\%$$

$$\text{Width \% Section 2} = 35' \div 70' = .5 \text{ or } 50\%$$

$$\text{Width \% x Avg Length Section 1} = .50 \times 120' = 60'$$

$$\text{Width \% x Avg Length Section 2} = .5 \times 120' = 60'$$

$$\text{Effective depth} = 60' + 60' = 120'$$

Follow these guidelines when drawing additional depth lines to establish an accurate effective depth:

- Draw lines for establishing depth perpendicular to the frontage line.
- Draw these parallel lines with equal increments between them.
- Draw the lines to scale to make computation easier.

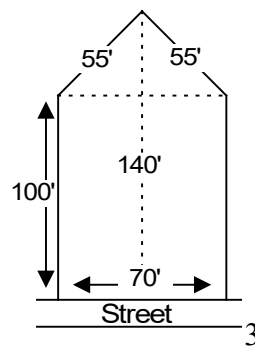

**Figure 2-3. Example of a Type 3 Platted Lot**

#### TYPE 4 LOT

The Type 4 lot is a more complicated variation of the lot shown in the prior table. The shape of this lot requires more depth lines in order to calculate the effective depth. Notice that the depth lines meet the criteria described in the previous section--they are perpendicular to the frontage, parallel to each other, drawn to scale.

The example lot has:

- an actual frontage of 80 feet (four sections of 20 feet)
- an effective frontage of 80 feet (four sections of 20 feet)
- an effective depth of 88 feet.

$$\begin{aligned}
 \text{Average Depth Section 1} &= 70' + 80' = 150' \div 2 = 75' \\
 \text{Average Depth Section 2} &= 80' + 90' = 170' \div 2 = 85' \\
 \text{Average Depth Section 3} &= 90' + 100' = 190' \div 2 = 95' \\
 \text{Average Depth Section 4} &= 100' + 90' = 190' \div 2 = 95'
 \end{aligned}$$

$$\begin{aligned}
 \text{Width \% Section 1} &= 20' \div 80' = .25 \text{ or } 25\% \\
 \text{Width \% Section 2} &= 20' \div 80' = .25 \text{ or } 25\% \\
 \text{Width \% Section 3} &= 20' \div 80' = .25 \text{ or } 25\% \\
 \text{Width \% Section 4} &= 20' \div 80' = .25 \text{ or } 25\%
 \end{aligned}$$

$$\begin{aligned}
 \text{Width \% x Avg. Length Section 1} &= .25 \times 75' = 18.75' \\
 \text{Width \% x Avg. Length Section 2} &= .25 \times 85' = 21.25' \\
 \text{Width \% x Avg. Length Section 3} &= .25 \times 95' = 23.75' \\
 \text{Width \% x Avg. Length Section 4} &= .25 \times 95' = 23.75'
 \end{aligned}$$

$$\text{Effective Depth} = 18.75' + 21.25' + 23.75' + 23.75' = 87.50'$$

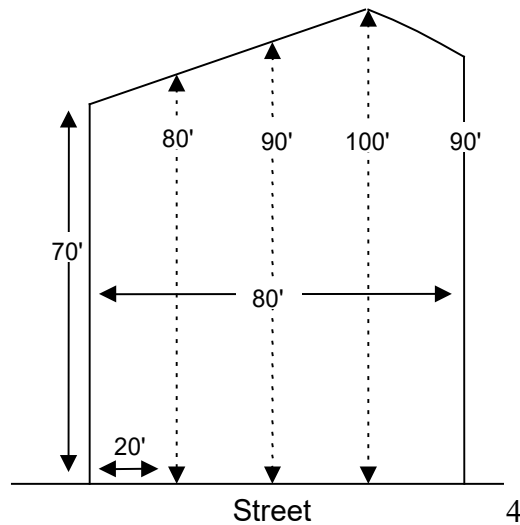

**Figure 2-4. Example of a Type 4 Platted Lot**

#### TYPE 5 LOT

The Type 5 lot, shown below, is a right triangle with the base of the triangle located at the street. There are only two perpendicular lines. When any lot or portion of a lot forms a right triangle, and the base is on the street, use the following guidelines:

- Apply a percentage factor to establish the effective frontage.
- The actual frontage is the line that runs parallel to the street.
- Use a factor of 65% to determine the effective frontage.
- The depth is the line that is perpendicular to the frontage.

To calculate the effective frontage of such a lot, multiply the actual frontage by the percentage factor:

$$\text{Effective frontage} = \text{Actual frontage} \times \text{Percentage factor}$$

The example lot has:

- an actual frontage of 100 feet
- an effective frontage of 65 feet ( $100' \times .65 = 65'$ )
- an effective depth of 100 feet.

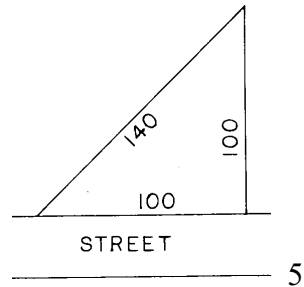

**Figure 2-5. Example of a Type 5 Platted Lot**

### TYPE 6 LOT

The Type 6 lot is a right triangle with the apex of the triangle located at the street. There are only two perpendicular lines. When any lot, or a portion of a lot, forms a right triangle, and the apex is on the street:

- Apply a percentage factor to establish the effective frontage.
- The actual frontage is zero.
- Use a factor of 35% to determine the effective frontage.
- The depth is the line that is perpendicular to the frontage.

To calculate the effective frontage, multiply the actual length of the rear line by the percentage factor:

$$\text{Effective frontage} = \text{Rear line} \times \text{Percentage factor}$$

The example lot has:

- an actual frontage of 0 feet
- an effective frontage of 18 feet ( $50' \times .35 = 17.5'$ )
- an effective depth of 110 feet.

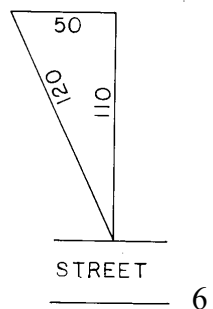

**Figure 2-6. Example of a Type 6 Platted Lot**



**TYPE 7 LOT**

In the Type 7 lot, the width lines are parallel. However, the depth lines are not parallel to each other and are not perpendicular to the frontage line. In such a case, first draw depth lines that are parallel to the frontage and to scale. Drawing depth lines results in the creation of three figures within this lot—two right triangles with the bases of both located on the street and one 100% lot.

To calculate the effective frontage of such a lot, perform these steps:

**STEP 1** To determine the actual frontage of the two triangles, subtract the width of the 100% lot from the actual front footage:

$$\text{Actual frontage of triangles} = \text{Actual frontage} - \text{Width of 100\% lot}$$

**STEP 2** To determine the effective frontage of the two triangles, multiply the actual frontage of the triangles by the percentage factor of 65%:

$$\text{Effective frontage of triangles} = \text{Actual frontage of triangles} \times .65$$

**STEP 3** To determine the effective frontage of the lot, add the effective frontage of the triangle and the effective frontage of the 100% lot:

$$\text{Effective frontage of lot} = \text{Effective frontage of triangles} + \text{Effective frontage of 100\% lot}$$

The example lot has:

- an actual frontage of 140 feet
- an effective frontage of 112 feet ( $140' - 60' = 80' \times .65 = 52' + 60' = 112'$ )
- an effective depth of 105 feet.

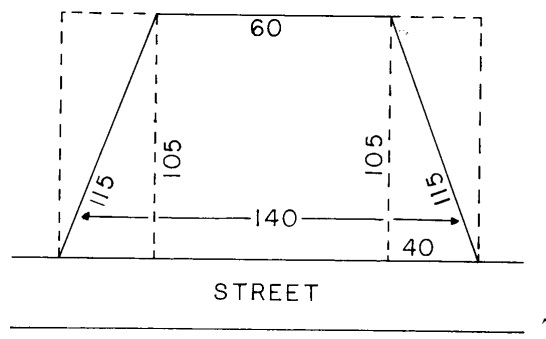

**Figure 2-7. Example of a Type 7 Platted Lot**

**TYPE 8 LOT**

The Type 8 lot is the reverse of the Type 7 lot. The width lines are parallel, but the longest width is at the rear. The depth lines are not parallel to each other and not perpendicular to the frontage line.

In such a case, first draw depth lines that are parallel to the frontage and to scale. Drawing depth lines creates three figures within the lot—two triangles with the apex on the street and one 100% lot. To calculate the effective frontage of such a lot, perform these steps:

**STEP 1** To determine the actual frontage of the two triangles, subtract the width of the 100% lot from the actual width of the lot at its widest section:

$$\text{Actual frontage of triangles} = \text{Actual frontage} - \text{Width of 100\% lot}$$

**STEP 2** To determine the effective frontage of the two triangles, multiply the width of the triangles by the percentage factor of 35%:

$$\text{Effective frontage of triangles} = \text{Actual frontage of triangles} \times .35$$

**STEP 3** To determine the effective frontage of the lot, add the effective frontage of the triangles and the effective frontage of the 100% lot:

$$\text{Effective frontage of lot} = \text{Effective frontage of triangles} + \text{Effective frontage of 100\% lot}$$

The example lot has:

- an actual frontage of 50 feet
- an effective frontage of 68 feet ( $100' - 50' = 50' \times .35 = 17.5' + 50' = 67.5'$ )
- an effective depth of 105 feet.

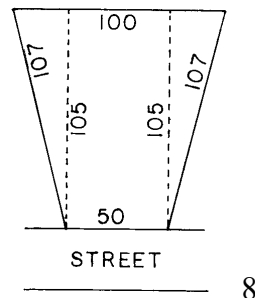

**Figure 2-8. Example of a Type 8 Platted Lot**

### TYPE 9 LOT

The lot shown below does not have any two lines perpendicular or parallel. The line that is parallel to the street is the frontage. For such a lot, use the frontage line to square the lot. Draw depth lines perpendicular to the frontage and to scale. Also, draw

a width line parallel to the frontage and perpendicular to the depth lines. Drawing the dashed lines creates four figures.

To calculate the *effective depth* of this type of lot, perform the following steps:

**STEP 1** Add the length of the two depth lines.

**STEP 2** Divide the total by two to determine the average depth.

To calculate the *effective frontage*, perform the following steps:

**STEP 1** To calculate the effective front footage of the triangle with the apex at the rear of the lot, multiply the length of the base of the triangle by the percentage factor of 65%:

$$\text{Effective Frontage of Triangle} = \text{Length of Base of Triangle} \times .65$$

**STEP 2** To calculate the effective front footage of the triangle with the apex at the front of the lot, multiply the length of the base of the triangle by the percentage factor of 35%:

$$\text{Effective Frontage of Triangle} = \text{Length of Base of Triangle} \times .35$$

**STEP 3** To calculate the effective front footage of the lot, add the effective front footage of the 100% lot to the effective front footage of the two triangles:

$$\text{Effective Frontage of Lot} = \text{Effective Frontage of Triangles} + \text{Effective Frontage of 100\% Lot}$$

The example lot has:

- an actual frontage of 130 feet
- an effective frontage of 132 feet  
 $((20' \times .65 = 13') + (25' \times .35 = 8.75') = 21.75' + 110' = 131.75')$
- an effective depth of 95 feet  $(100 + 90 = 190 \div 2)$ .

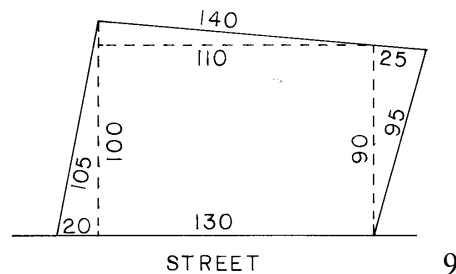

**Figure 2-9. Example of a Type 9 Platted Lot**

**TYPE 10 LOT**

The Type 10 lot is a double entry lot. The lines are perpendicular and parallel. By drawing a dashed line, two figures are formed within the lot. For this type of lot, record two frontages and two depths. Determine the effective frontage and effective depth of each area of the lot as you would for a 100% lot.

The left portion of the example lot has:

- an actual frontage of 50 feet
- an effective frontage of 50 feet
- an effective depth of 100 feet.

The right portion of the lot has:

- an actual frontage of 20 feet
- an effective frontage of 20 feet
- an effective depth of 140 feet

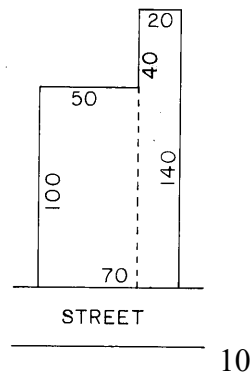

**Figure 2-10. Example of a Type 10 Platted Lot**

**TYPE 11 LOT**

Lot 2 in the figure below is a double entry lot. It differs from the previous example because it has a 50 feet by 50 feet portion at the rear of Lot 3 that has no street frontage. This area is called a rear lot.

The rear portion of Lot 2 (the rear lot), located behind Lot 3, has:

- an actual frontage of 0 feet
- an effective frontage of 50 feet
- an effective depth of 50 feet.

The left portion of Lot 2 (the front lot) has:

- an actual frontage of 50 feet
- an effective frontage of 50 feet
- an effective depth of 200 feet.

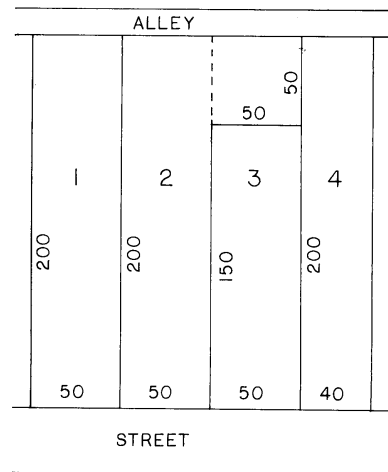

Figure 2-11. Example of a Type 11 Platted Lot

### TYPE 12 LOT

The Type 12 lot is a cul-de-sac lot. To determine the *effective frontage* of such a lot, follow these steps:

- STEP 1** Establish the gross width of the lot by finding and measuring the widest part of the lot (185 feet in the example).
- STEP 2** Draw lines for a 100% lot so that it encompasses the area most likely to include the dwelling.
- STEP 3** Draw and measure lines perpendicular to the gross width lines and to scale. Determine the effective frontage of the 100% lot.
- STEP 4** The remainder of the lot forms two triangles with their apex on the street. To determine the effective frontage of the remainder of the lot, subtract the width of the 100% lot from the gross width line of the lot and multiply by a percentage factor of .35:

$$\text{Effective Frontage of Remainder} = (\text{Gross Width Line of Lot} - (\text{Width of 100\% Lot} \times .35))$$

- STEP 5** To calculate the effective frontage of the lot, add the width of the 100% lot to the effective frontage of the remainder of the lot:

$$\text{Effective Frontage of Lot} = \text{Width of 100\% Lot} + \text{Effective Frontage of Remainder}$$

To determine the *effective depth* of the lot, follow these steps:

- STEP 1** Add the length of the two depth lines.

**STEP 2** Divide the total by two to determine the average depth.

The example lot has:

- an actual frontage of 120 feet
- an effective frontage of 143 feet (The gross width is 185 feet and the width of the 100% lot is 120 feet.)  
( $185' - 120' = 65' \times .35 = 22.75' + 120' = 142.75'$ ).
- an effective depth of 163 feet ( $150' + 175' = 325' \div 2 = 162.5'$ ).

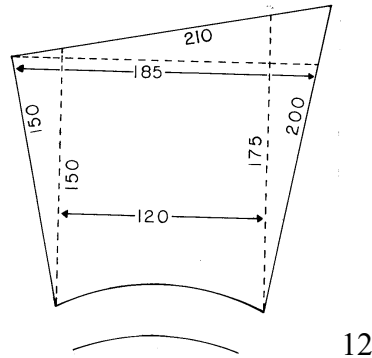

**Figure 2-12. Example of a Type 12 Platted Lot**

### Determining Depth Factors for Platted Lots

Each assessing official must designate the base lot size for each neighborhood identified on the land value map. If the majority of the lots are platted at 50 feet by 150 feet, the base lot size for the area is 50 feet by 150 feet. The establishment of the base lot creates the standard against which all other lots within the neighborhood are compared.

The depth factor is a multiplier that you apply to a unit land value to adjust the value of a particular lot to account for the depth of the lot. The depth table adjusts the lot value of those lots that have either less depth or more depth than the standard established for the neighborhood. The depth tables let you select the appropriate depth factor for a lot. Select the depth table corresponding to the standard lot depth for the neighborhood to determine the appropriate depth factor for a lot.

The process for determining the depth factor of a front lot is different from the process of determining the depth factor for a rear lot.

To determine the depth factor for a *front lot*, perform the following steps:

- STEP 1** Determine the effective depth of the entire lot.
- STEP 2** In *Table 2-6* through *Table 2-8*, locate the lot depth table that corresponds to the standard lot depth determined for the neighborhood.

- STEP 3** In the “Depth” column in the selected depth table, locate the row corresponding to the effective depth of the lot (in feet).
- STEP 4** Find the intersection of the selected row (effective depth) and the “Factor” column. Note the number—the depth factor for the lot.

The depth factor for the *rear lot* must be manually entered. To determine the depth factor of a *rear lot*, perform the following steps:

- STEP 1** Determine the overall depth of the lot by measuring from the street to the rear of the rear lot. If you have not already done so, determine the effective depth of the front lot.
- STEP 2** In *Table 2-6* through *Table 2-8*, locate the lot depth table that corresponds to the standard lot depth determined for the neighborhood.
- STEP 3** In the “Depth” column in the selected depth table, locate the overall depth of the lot.
- STEP 4** Find the intersection of the selected row (overall depth) and the “Factor” column. Note the number that you find—the overall depth factor.
- STEP 5** In the selected depth table, locate the effective depth of the front lot.
- STEP 6** Find the intersection of the selected row (effective depth of the front lot) and the “Factor” column. Note the number—the front lot depth factor.
- STEP 7** To determine the depth factor of the rear lot, subtract the front lot depth factor (determined in Step 6) from the overall depth factor (determined in Step 4):

$$\begin{array}{rclcl} \text{Rear Lot} & = & \text{Overall} & - & \text{Front Lot} \\ \text{Depth Factor} & & \text{Depth Factor} & & \text{Depth Factor} \end{array}$$

To use the depth factor to calculate the value of a parcel that has a depth different from the standard depth in the area, multiply the base rate by the depth factor:

$$\text{Adjusted Rate} = \text{Base Rate} \times \text{Depth Factor}$$

**Example 1:** The standard lot for Neighborhood #6 is 100 feet by 150 feet deep. Lot #1 is 100 feet wide by 125 feet deep. The base rate in the area is \$100. In the lot depth table for 150 feet standard depth, locate 125 feet and the corresponding depth factor (.92). To determine the adjusted value of Lot #1, multiply the base rate by the depth factor (\$100 x .92 = \$92). Then, multiply the adjusted rate by the front footage (\$92 x 100' = \$9,200).

**Example 2:** Lot #10 is located in Neighborhood #6 and is 100 feet by 150 feet. It is considered a rear lot because it sits directly behind Lot #1 and has no street access. The overall depth of both Lot #1 and Lot #10 is 300 feet. In the lot depth table for 150 feet standard depth, locate 300 feet and the corresponding depth factor (1.16). The depth factor for Lot #10 represents the difference between the

overall depth factor (1.16) and the depth factor (.92) of the front lot. The calculated depth factor ( $1.16 - .92 = .24$ ) is the depth factor for Lot #10. To determine the adjusted value of Lot #10, multiply the base rate by the depth factor ( $\$100 \times .24 = \$24$ ). Then, multiply the adjusted rate by the front footage ( $\$24 \times 100' = \$2,400$ ).

**Note:** If the depth of the subject lot lies between two of those published on the chart, choose the lower depth factor of the two.



Table 2-6. Lot Depth Tables (100 and 120 Feet Standard Depth)

100 Feet Standard Depth				120 Feet Standard Depth			
Depth	Factor	Depth	Factor	Depth	Factor	Depth	Factor
1	.07	51	.74	101	1.00	151	1.14
2	.09	52	.75	102	1.01	152	1.15
3	.11	53	.75	103	1.01	153	1.15
4	.13	54	.76	104	1.01	154	1.15
5	.15	55	.77	105	1.01	155	1.15
6	.17	56	.78	106	1.02	156	1.15
7	.19	57	.78	107	1.02	157	1.16
8	.21	58	.79	108	1.02	158	1.16
9	.23	59	.79	109	1.03	159	1.16
10	.25	60	.80	110	1.03	160	1.16
11	.27	61	.81	111	1.03	161	1.16
12	.29	62	.81	112	1.03	162	1.17
13	.31	63	.82	113	1.04	163	1.17
14	.33	64	.82	114	1.04	164	1.17
15	.35	65	.83	115	1.04	165	1.17
16	.37	66	.84	116	1.05	166	1.17
17	.38	67	.84	117	1.05	167	1.17
18	.40	68	.85	118	1.05	168	1.18
19	.41	69	.85	119	1.06	169	1.18
20	.43	70	.86	120	1.06	170	1.18
21	.44	71	.87	121	1.06	175	1.18
22	.46	72	.87	122	1.07	180	1.19
23	.47	73	.88	123	1.07	185	1.20
24	.49	74	.88	124	1.07	190	1.20
25	.50	75	.89	125	1.08	195	1.21
26	.51	76	.89	126	1.08	200	1.21
27	.52	77	.90	127	1.08	205	1.21
28	.53	78	.90	128	1.08	210	1.21
29	.54	79	.91	129	1.09	215	1.21
30	.55	80	.91	130	1.09	220	1.22
31	.56	81	.92	131	1.09	225	1.22
32	.57	82	.92	132	1.10	230	1.22
33	.58	83	.93	133	1.10	235	1.22
34	.59	84	.93	134	1.10	240	1.23
35	.60	85	.94	135	1.10	250	1.23
36	.61	86	.94	136	1.11	260	1.24
37	.62	87	.95	137	1.11	270	1.24
38	.63	88	.95	138	1.11	280	1.25
39	.64	89	.96	139	1.12	290	1.25
40	.65	90	.96	140	1.12	300	1.26
41	.66	91	.96	141	1.12	310	1.26
42	.67	92	.97	142	1.12	320	1.27
43	.67	93	.97	143	1.13	330	1.27
44	.68	94	.98	144	1.13	340	1.28
45	.69	95	.98	145	1.13	350	1.28
46	.70	96	.98	146	1.13	360	1.29
47	.71	97	.99	147	1.14	370	1.29
48	.71	98	.99	148	1.14	380	1.30
49	.72	99	1.00	149	1.14	390	1.30
50	.73	100	1.00	150	1.14	400	1.31
1	.03	51	.65	101	.91	151	1.12
2	.05	52	.65	102	.92	152	1.12
3	.08	53	.66	103	.92	153	1.12
4	.10	54	.66	104	.93	154	1.12
5	.13	55	.67	105	.93	155	1.13
6	.15	56	.68	106	.94	156	1.13
7	.17	57	.68	107	.94	157	1.13
8	.19	58	.69	108	.95	158	1.13
9	.21	59	.69	109	.95	159	1.14
10	.24	60	.70	110	.96	160	1.14
11	.26	61	.71	111	.96	161	1.14
12	.27	62	.71	112	.97	162	1.14
13	.29	63	.72	113	.97	163	1.15
14	.31	64	.73	114	.97	164	1.15
15	.33	65	.73	115	.98	165	1.15
16	.35	66	.74	116	.98	166	1.15
17	.36	67	.75	117	.99	167	1.15
18	.38	68	.75	118	.99	168	1.16
19	.40	69	.76	119	1.00	169	1.16
20	.41	70	.76	120	1.00	170	1.16
21	.42	71	.77	121	1.00	175	1.17
22	.43	72	.78	122	1.01	180	1.18
23	.44	73	.78	123	1.01	185	1.19
24	.45	74	.79	124	1.02	190	1.20
25	.46	75	.79	125	1.02	195	1.21
26	.47	76	.80	126	1.03	200	1.22
27	.48	77	.80	127	1.03	205	1.22
28	.48	78	.81	128	1.03	210	1.23
29	.49	79	.81	129	1.04	215	1.23
30	.50	80	.82	130	1.04	220	1.23
31	.51	81	.82	131	1.05	225	1.23
32	.52	82	.83	132	1.05	230	1.24
33	.53	83	.83	133	1.05	235	1.24
34	.53	84	.84	134	1.06	240	1.24
35	.54	85	.84	134	1.06	250	1.25
36	.55	86	.85	136	1.07	260	1.25
37	.56	87	.85	137	1.07	270	1.25
38	.57	88	.86	138	1.07	280	1.25
39	.57	89	.86	139	1.08	290	1.26
40	.58	90	.87	140	1.08	300	1.26
41	.59	91	.87	141	1.08	310	1.26
42	.59	92	.87	142	1.09	320	1.26
43	.60	93	.88	143	1.09	330	1.27
44	.60	94	.88	144	1.09	340	1.27
45	.61	95	.89	145	1.10	350	1.27
46	.62	96	.89	146	1.10	360	1.27
47	.62	97	.90	147	1.10	370	1.28
48	.63	98	.90	148	1.11	380	1.28
49	.63	99	.91	149	1.11	390	1.28
50	.64	100	.91	150	1.11	400	1.28

Table 2-7. Lot Depth Tables (132 and 150 Feet Standard Depth)

132 Feet Standard Depth				150 Feet Standard Depth			
Depth	Factor	Depth	Factor	Depth	Factor	Depth	Factor
1	.03	51	.62	101	.89	151	1.06
2	.05	52	.63	102	.90	152	1.06
3	.07	53	.64	103	.90	153	1.06
4	.09	54	.64	104	.90	154	1.07
5	.10	55	.65	105	.91	155	1.07
6	.12	56	.66	106	.91	156	1.07
7	.13	57	.66	107	.91	157	1.07
8	.15	58	.67	108	.92	158	1.08
9	.17	59	.68	109	.92	159	1.08
10	.19	60	.69	110	.93	160	1.08
11	.20	61	.69	111	.93	161	1.08
12	.21	62	.70	112	.94	162	1.09
13	.23	63	.70	113	.94	163	1.09
14	.24	64	.71	114	.94	164	1.09
15	.26	65	.72	115	.95	165	1.09
16	.27	66	.72	116	.95	166	1.10
17	.29	67	.73	117	.95	167	1.10
18	.30	68	.73	118	.95	168	1.10
19	.32	69	.74	119	.96	169	1.10
20	.33	70	.74	120	.96	170	1.11
21	.34	71	.75	121	.96	175	1.12
22	.35	72	.75	122	.97	180	1.12
23	.37	73	.76	123	.97	185	1.13
24	.38	74	.76	124	.97	190	1.14
25	.39	75	.77	125	.98	195	1.14
26	.40	76	.77	126	.98	200	1.15
27	.41	77	.78	127	.98	205	1.15
28	.42	78	.78	128	.99	210	1.16
29	.43	79	.79	129	.99	215	1.16
30	.44	80	.80	130	.99	220	1.16
31	.45	81	.80	131	1.00	225	1.16
32	.46	82	.80	132	1.00	230	1.17
33	.47	83	.81	133	1.00	235	1.17
34	.48	84	.81	134	1.01	240	1.17
35	.49	85	.82	135	1.01	250	1.18
36	.50	86	.82	136	1.01	260	1.18
37	.51	87	.83	137	1.02	270	1.19
38	.52	88	.84	138	1.02	280	1.19
39	.53	89	.84	139	1.02	290	1.20
40	.54	90	.85	140	1.03	300	1.20
41	.54	91	.85	141	1.03	310	1.21
42	.55	92	.86	142	1.03	320	1.21
43	.56	93	.86	143	1.04	330	1.22
44	.56	94	.86	144	1.04	340	1.22
45	.57	95	.87	145	1.04	350	1.23
46	.58	96	.87	146	1.05	360	1.23
47	.59	97	.88	147	1.05	370	1.24
48	.60	98	.88	148	1.05	380	1.24
49	.61	99	.89	149	1.06	390	1.25
50	.62	100	.89	150	1.06	400	1.25
1	.03	51	.57	101	.82	151	1.00
2	.04	52	.58	102	.83	152	1.01
3	.05	53	.58	103	.83	153	1.01
4	.07	54	.59	104	.84	154	1.01
5	.08	55	.59	105	.84	155	1.02
6	.10	56	.60	106	.85	156	1.02
7	.12	57	.60	107	.85	157	1.02
8	.13	58	.61	108	.86	158	1.03
9	.14	59	.62	109	.86	159	1.03
10	.15	60	.62	110	.86	160	1.03
11	.17	61	.63	111	.87	161	1.04
12	.19	62	.63	112	.87	162	1.04
13	.20	63	.64	113	.88	163	1.04
14	.21	64	.65	114	.88	164	1.05
15	.22	65	.65	115	.88	165	1.05
16	.24	66	.66	116	.89	166	1.05
17	.25	67	.66	117	.89	167	1.06
18	.26	68	.67	118	.89	168	1.06
19	.27	69	.67	119	.90	169	1.06
20	.28	70	.68	120	.90	170	1.06
21	.30	71	.68	121	.90	175	1.07
22	.31	72	.69	122	.91	180	1.08
23	.32	73	.69	123	.91	185	1.09
24	.33	74	.70	124	.92	190	1.10
25	.34	75	.70	125	.92	200	1.11
26	.35	76	.70	126	.92	210	1.11
27	.36	77	.71	127	.93	215	1.11
28	.37	78	.71	128	.93	220	1.12
29	.38	79	.72	129	.94	225	1.12
30	.39	80	.72	130	.94	230	1.12
31	.40	81	.73	131	.94	235	1.12
32	.41	82	.73	132	.95	240	1.13
33	.42	83	.74	133	.95	250	1.13
34	.43	84	.74	134	.95	260	1.14
35	.43	85	.75	135	.96	270	1.14
36	.44	86	.75	136	.96	280	1.15
37	.45	87	.76	137	.96	290	1.15
38	.46	88	.77	138	.97	300	1.16
39	.47	89	.77	139	.97	310	1.16
40	.48	90	.78	140	.97	320	1.17
41	.49	91	.78	141	.98	330	1.17
42	.50	92	.79	142	.98	340	1.18
43	.51	93	.79	143	.98	350	1.18
44	.52	94	.80	144	.99	360	1.19
45	.52	95	.80	145	.99	370	1.19
46	.53	96	.80	146	.99	380	1.20
47	.54	97	.81	147	.99	390	1.20
48	.55	98	.81	148	1.00	400	1.21
49	.56	99	.82	149	1.00		
50	.56	100	.82	150	1.00		



On Lot #62 of the subdivision, there is a one family dwelling with a yard that occupies approximately the front 90 feet of the lot. The remaining 30 feet of the lot is a ravine that cannot be utilized. The lot sold for less than the standard lots. The ravine area was the reason for the lower price. Because the area was developed in the 1950s, the original sales information is no longer accessible.

In this case, the assessing official may apply an influence factor because of the adverse topography. The assessor estimates the difference in value between this lot and the standard lot as \$1,000, or 8 1/3% of the selling price of the standard lots. The assessor applies an 8% influence factor to the subject lot.

### **Absence of Land Improvements Example**

Lot #86 is located in Neighborhood #1. It is the standard lot size and is vacant. There is no water or sewage disposal system installed on the property. The lot value of \$12,000, established by the assessing official, represents an improved lot value with either water or sewage utilities, water well and septic system, or a combination of both. Other improvement costs associated with this land are driveways, private walkways, and an allowance for typical landscaping. Because Lot #86 does not have these services, an adjustment or influence factor is necessary.

The assessor surveys the jurisdiction to determine the amount included in the value of improved land for the various land improvement costs. Improvement costs affect individual lots differently based on the estimated improved land value. For a less valuable area, the influence factor percentage is higher than for a more valuable area because the land improvement cost represents a higher percentage of the total land value.

The assessing official contacted the utility companies servicing this neighborhood and determined that lot owners are charged \$900 to tap into the existing systems. The assessor estimated that it costs an additional \$700 to run water and sewer lines from the existing utilities to the normal placement of a dwelling of this lot. The total cost to improve this lot with water and sewer for a dwelling is \$1,600 ( $\$700 + \$900 = \$1,600$ ). The cost of installing utilities is depreciated by the assessor in this neighborhood by 50% to obtain a partial adjustment of \$800. The assessor estimates that the improvement costs for a residential driveway, typical landscaping, and private sidewalks is equal to \$1,000. The total cost attributed to improve a residential lot in this neighborhood is \$1,800 ( $\$800 + \$1,000 = \$1,800$ ). To determine the influence factor, divide the adjustment by the value for the lot before the adjustment ( $\$1,800 \div \$12,000 = .15$  or 15%).

The assessor applies a negative 15% influence factor for “under improved” to each vacant lot, until such time when the lot is improved. For each neighborhood, the assessor develops the estimated amount included in the value to improve the land. The deduction for a lack of improvements affects individual lots differently based on the estimated improved land value. For less valuable neighborhoods, the influence factor percentage would tend to be higher than in the more valuable neighborhoods

because the land improvement addition increase represents a higher percentage of the total land value.

### **Excessive Frontage Example**

In Neighborhood #1, the standard lot width is 60 feet. The assessor has established a base rate of \$200 per front foot. Lot #1 and Lot #2 are not typical lots of the subdivision because they have street frontage equal to 90 feet instead of 60 feet. These lots contain the original subdivision model homes, which were built in the middle of the 90 foot lots.

Neither dwelling design requires 90 feet of frontage. Both dwellings would fit on the 60 foot lots located throughout the subdivision.

The value of a 60 feet lot is \$12,000. The 90 feet lots are not worth 50% more than the standard lots. A value of \$18,000 for the lots is too high. However, the lots are worth more than \$12,000.

The dwellings were built in the middle of the lots. There is a 60 feet lot with two 15 feet strips of land on either side. The 60 feet portion of the lots is comparable to the standard lot established for the area. The two 15 feet strips are classified as excessive frontage. The assessor estimates that these lots are worth approximately \$15,000 each. To reinforce this opinion, the assessor calculates the 30 feet of excess frontage at 50% loss of value ( $30' \times \$200 \times .50 = \$3,000$ ). To determine the influence factor, divide the adjustment by the unadjusted value ( $\$3,000 \div \$18,000 = .16666$  or  $16 \frac{2}{3}\%$ ). The assessor grants an excessive frontage influence factor of 17% to Lot #1 and Lot #2. This adjustment equals a deduction of \$3,060. The land value of each lot is \$14,940 ( $\$18,000 - \$3,060 = \$14,940$ ).

### **Completing the Land Data and Computations Section of the Property Record Card for Platted Lots**

This section describes how to complete the “Land Data and Computations” section of a Property Record Card for a platted lot. The steps describe how to use the front foot method to calculate the value of the lot. The steps for completing the Property Record Card are grouped into two tasks, described in the sections below:

- Task 1—Record the necessary data for the lot.
- Task 2—Calculate the land value for the lot.

#### **Task 1—Recording the Necessary Data**

Space is provided on both the residential and the commercial/industrial Property Record Cards to compute the land value of each lot entry for a platted lot. Enter the data into a series of columns using one row per entry. For example, if a lot is composed of a rear lot and a front lot, enter the rear lot and the front lot as separate entries.

To enter the data for a platted lot, perform these steps:

- STEP 1** In the “Land Type” column, enter the code corresponding to the land type classification of the lot entry. *Table 2-9* describes the land type options for platted lot entries.

**Table 2-9. Land Type Options for Platted Lots**

This option	Indicates
F	The lot fronts the street and is computed as a front lot.
R	The lot has no street access and is computed as a rear lot.

- STEP 2** In the “Actual Frontage” column, enter the actual front foot dimensions of the lot entry. Round to the nearest 1/10 (.1) foot.
- STEP 3** In the “Effective Frontage” column, enter either the figured frontage of an irregularly shaped lot or the usable frontage of a lot (as determined by the assessor). Round to the nearest foot. Instructions for determining the effective frontage of a lot are provided in the section “*Establishing the Effective Frontage and Depth of Platted Lots*” in this chapter.
- STEP 4** In the “Effective Depth” column, enter the average or computed depth, as in the case of irregularly shaped lots, or the usable depth (as determined by the assessor). Round to the nearest foot. Instructions for determining the effective depth of a lot are provided in the section “*Establishing the Effective Frontage and Depth of Platted Lots*” in this chapter.
- STEP 5** In the “Depth Factor” column, enter the depth factor used to adjust the base rate or unit value to account for depth variations from the norm. Instructions for determining the depth factor of a lot are provided in the section “*Determining the Depth Factor for Platted Lots*” in this chapter.
- STEP 6** In the “Base Rate” column, enter the front foot rate for the area as determined by the jurisdiction assessor and modified/approved by the Property Tax Assessment Board of Appeals.
- STEP 7** In the “Influence Factor” column, indicate any condition peculiar to the lot that requires an adjustment to the estimated value to account for variations from the base lot on which the base unit land value for the neighborhood is predicated. Enter a single digit numeric code to indicate the nine most prevalent factors and the other factors (code 0) not indicated elsewhere on the Property Record Card. Any time code 0 is entered, describe the specific factor in the memorandum section on the property record card.
- a. Enter the influence code to the left of the brackets.

- b. Enter the percentage adjustment to the right of the brackets.
- c. Within the brackets, enter a plus (+) to indicate an increase. Enter a minus (–) to indicate a decrease. *Table 2-10* describes the influence factor codes. Information about influence factors is provided in the section “*Determining Influence Factors for Platted Lots*” in this chapter.

**Table 2-10. Influence Factor Codes for Platted Lots**

<b>This code</b>	<b>Indicates</b>
1 Topography	A decrease based on adverse topographical features.
2 Under Improved	A decrease based on the under improvement of landscaping, residential driveways and private walkways, and utility hookups.
3 Excess Frontage	A decrease based on the lower utility value of frontage that is significantly in excess of the base lot frontage.
4 Shape or Size	A decrease based on an irregularity in shape that limits the use of the parcel <b>or</b> a decrease for an oversized lot whose variations are not accounted for elsewhere.  An increase based on an irregularity in shape that enhances the use of the parcel <b>or</b> an increase for an undersized lot whose variations are not accounted for elsewhere.
5 Mis-improvement	A decrease indicating a lot that has been valued higher than its current use. The value must be lowered to the level of comparable properties in the subject neighborhood.
6 Restrictions	A decrease based on encumbrances, restrictive covenants, or obstructions that limit the use of the land.
7 Traffic Flow	A decrease to account for the nuisance of significantly heavier traffic flow that affects the base lot and is not considered in the base lot value.
8 View	A decrease to account for variations in view from the subject lot and not from the base lot that detracts from the subject lot.  An increase to account for variations in view from the subject lot and not from the base lot that enhances the subject lot.
9 Corner Influence	A decrease to account for building restrictions, such as double set backs and increased traffic flow, that detract from the subject lot and are not considered in the base lot value.  An increase to account for building restrictions, such as double set backs and increased traffic flow, that offer commercial benefits and are not considered in the base lot value.

O Other	<p>An influence, not described above, such as the following,. Describe the factor in the memorandum section.</p> <ul style="list-style-type: none"> <li>■ <b>Golf course</b>—An increase to account for a particular location enhancement, not characteristic of the base lot.</li> <li>■ <b>Water frontage</b>—An increase to account for proximity to a water front, not characteristic of the base lot.</li> <li>■ <b>Cul-de-sac</b>—An increase to account for shape or size enhancements due to a cul-de-sac location, not characteristic of the base lot.</li> <li>■ <b>Location</b>—An increase or decrease to account for the influence of a particular location and not considered in the base lot.</li> <li>■ <b>Soil conditions</b>—A decrease to account for adverse soil conditions that prohibit the subject lot being used the same as the base lot.</li> <li>■ <b>Drainage</b>—A decrease to account for drainage limitations, indicated by standing water, not characteristic of the base lot.</li> <li>■ <b>Flooding susceptibility</b>—A decrease to account for a lot or a portion of a lot being in a flood plain, not characteristic of the base lot.</li> <li>■ <b>Noise nuisance</b>—A decrease to account for extraneous noise or other such nuisances not characteristic of the base lot.</li> <li>■ <b>Excess depth</b>—A decrease to account for a disproportionate frontage depth not accounted for in the size adjustment factor.</li> <li>■ <b>Limited access</b>—A decrease to account for ingress or egress limitations not characteristic of the base lot.</li> </ul>
---------	---

**STEP 8** Repeat Step 1 through Step 7 for each lot entry.

### **Task 2—Calculating the Land Value**

Next, use the data that you entered on the property record card to calculate the land value for the platted lot. Perform these steps:

**STEP 1** Calculate the adjusted rate for the lot entry by multiplying the base rate by the depth factor:

$$\text{Adjusted Rate} = \text{Base Rate} \times \text{Depth Factor}$$

Round the adjusted rate to the nearest \$1 and enter it in the “Adjusted Rate” column.



**STEP 2** Calculate the estimated value of the lot entry by multiplying the effective frontage by the adjusted rate:

$$\text{Estimated Value} = \text{Effective Frontage} \times \text{Adjusted Rate}$$

Round the estimated value to the nearest \$10 and enter it in the “Estimated Value” column.

**STEP 3** Calculate the land value of the lot entry by adjusting the estimated value by the influence factor:

$$\text{Land Value} = \text{Estimated Value} \times (1.00 - \text{Influence Factor Percentage})$$

Round the land value to the nearest \$10 and enter it in the “Land Value” column.

**Note:** A positive influence factor would be an addition to the influence factor percentage of 1.00. If there is no influence factor, the land value is the same as the estimated value.

**STEP 4** Perform Step 1 through Step 3 for each lot entry.

**STEP 5** Calculate the total residential land value by summing the entries in the “Land Value” column that represent residential land. Round the total residential land value to the nearest \$100 and enter it in the “Total Residential Land Value” cell.

**STEP 6** Calculate the total non-residential land value by summing the entries in the “Land Value” column that represent non-residential land. Round the total non-residential land value to the nearest \$100 and enter it in the “Total Non-Residential Land Value” cell.

**Example:** *Figure 2-13* shows the dimensions of three lots. The front lot is 100 feet by 100 feet. The rear lot behind it is 100 feet by 120 feet. Another rear lot is located behind the first rear lot. The second rear lot is 100 feet by 140 feet. These lots are in a neighborhood where the standard depth is 100 feet and the base rate is \$50 per front foot.

Use the “Land Data and Computations” section of a property record card for these lots. This information is used to complete the property record card. As you review this figure, keep in mind the following points:

- The “Land Type” column indicates whether each lot is a front lot or rear lot.
- The actual frontage of each lot is determined from the lot plats.
- The effective frontage and effective depth are calculated following the instructions provided in the section *Establishing the Effective Frontage and Depth for Platted Lots* in this chapter.

- The depth factor is determined following the instructions in the section *Determining the Depth Factor for Platted Lots* in this chapter.
- The base rate is determined for the neighborhood by the jurisdiction assessor.

- The adjusted base rate for the front lot is:

$$\text{Adjusted Base Rate} = \text{Base Rate} \times \text{Depth Factor}$$

$$\$50 = \$50 \times 1.00$$

- The adjusted base rate for the first rear lot is:  $\$50 \times .22 = \$11$ .
- The adjusted base rate for the second rear lot is:

$$\$50 \times .07 = \$3.50 = \$4 \text{ rounded.}$$

- The estimated value of the front lot is:

$$\text{Estimated Value} = \text{Effective Frontage} \times \text{Adjusted Rate}$$

$$\$5,000 = 100' \times \$50$$

- The estimated value of the first rear lot is:  $100' \times \$11 = \$1,100$ .
- The estimated value of the second rear lot is:  $100' \times \$4 = \$400$ .
- Since there is no influence factor for any of the lots, the true tax value of each lot is the same as the lot's estimated value.
- The total residential land value for the parcel is the sum of the land values of the three lots. *In this case the total is considered residential land value because it is less than or equal to one acre.*

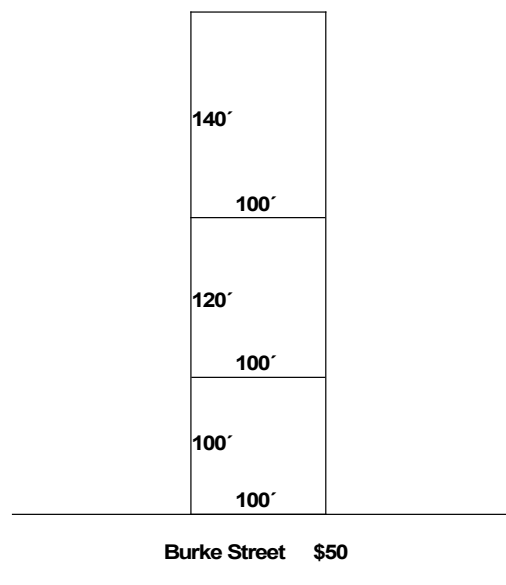

Figure 2-13. Dimensions of Example Lots

## Valuing Residential Acreage and Agricultural Homesites

---

There is a subtle distinction between residential acreage tracts and land valued using the agricultural soil productivity method. The basis for this distinction is the different valuation methods used to determine land value for the two types of land.

*Agricultural land* is valued using a statewide base rate and a soil productivity index system, as described in the section *Valuing Agricultural Land*. All land utilized for agricultural purpose is valued in this manner. *Residential land* is land that is utilized or zoned for residential purposes.

The parcel's size does not determine the property classification or pricing method for the parcel. The property classification and pricing method are determined by the property's use or zoning. Land purchased and utilized for residential purposes is based on market worth as of **January 1st**.

A land area of one acre per residential dwelling unit is assigned to agricultural parcels and residential parcels priced on an acreage basis. The value of this one acre land area is based on the January 1st cost of a vacant unimproved acre of land plus the current year costs of improving the land. Land improvement costs include the cost of landscaping, ingress and egress from the property, and the depreciated current year cost of improving the land with either a water well and septic system, or in the case of lands already developed with utility services, the material and labor costs associated with hook-up fees. The current year water and sewage additive reflects the overall depreciation assigned to existing facilities within the neighborhood, but may not be less than 50% of the current year cost of installing these improvements.

**Example:** In a neighborhood of the jurisdiction, a vacant unimproved one acre parcel sold for \$6,000. The actual water well and septic system expense is \$5,000. In this neighborhood, it has been determined that the land improvement costs equal an additional \$4,000. That amount was derived by attributing a 60% ratio for the well and septic and an additional \$1,000 for other miscellaneous land improvements ( $60\% \text{ of } \$5,000 = \$3,000 + \$1,000 = \$4,000$ ). The base rate applicable to the improved homesite is calculated by adding the vacant land cost to the land improvement costs ( $\$6,000 + \$4,000 = \$10,000$ ).

A parcel's value is influenced by its location. The value of unimproved land may vary substantially between two separate neighborhoods. A one acre unimproved parcel located in a remote neighborhood is less valuable than a one acre unimproved parcel located in a neighborhood on a lake at the edge of town. The difference in their value is attributable to the location difference. The demand for the lake parcel increases the value.

Not all neighborhoods are as diverse as the two in this example. The boundaries of the neighborhoods and their characteristics determine the amount of variation in value. It is impossible to create a precise formula that measures every variable

of location and converts those variables into a precise value. The assessor must analyze all variables in the market in order to measure the effects location has on land values.

### **Valuing Residential Acreage Parcels Larger Than One Acre**

Residential acreage parcels of more than one acre and not used for agricultural purposes are valued using the residential homesite base rate and the excess acreage base rate established by the assessing official. The excess acreage base rate represents the current year acreage value of land when purchased for residential purposes. The land value of the subject parcel should represent the January 1st market value in the neighborhood.

*If the parcel has a dwelling*, one acre is valued using the residential homesite value. The remaining acreage is valued using the excess acreage rate. There must be a residential dwelling unit on the parcel before the homesite acreage rate can be used.

*If there is no dwelling unit on the parcel*, the amount of acreage in the entire parcel is multiplied by the appropriate excess acre rate. The excess acre base rate represents the current year acreage value of the land purchased for residential purposes in this neighborhood. The value of the subject parcel should represent the January 1st market value of the property.

The following examples illustrate how residential acreage is valued for parcels larger than one acre. These examples assume a homesite base rate of \$10,000 (per acre) and an excess acreage base rate of \$1,000 (per acre).

**Example 1:** A residential parcel has 1.36 acres and a dwelling. The value of the one acre homesite is \$10,000. The value of the excess acreage (1.36 acres – 1 acre = .36 acre) is calculated by multiplying the acreage by the excess acreage base rate (.36 acre x \$1,000 = \$360). The total value of the parcel is the sum of the value of the homesite and the excess acreage (\$10,000 + \$360 = \$10,360 = \$10,400 rounded to the nearest \$100).

**Example 2:** A residential parcel is vacant and has three acres. Its value is calculated by multiplying the acreage by the excess acreage base rate (3 acres x \$1,000 = \$3,000).

**Example 3:** A residential parcel has 8 acres and a dwelling. The value of the one acre homesite is \$10,000. The value of the excess acreage (8 acres – 1 acre = 7 acres) is: 7 acres x \$1,000 = \$7,000. The total value of the parcel is: \$10,000 + \$7,000 = \$17,000.

### **Valuing Residential Acreage Parcels One Acre or Smaller**

Residential acreage parcels containing one acre or less are valued using the base rate (per acre) determined by the assessing official and the appropriate factor obtained from the Acreage Size Adjustment Table. Instructions for determining the size

adjustment factor for a parcel are provided in the section *Determining Size Adjustment Factors for Acreage* in this chapter. The size adjustment table compares smaller improved parcels to the established one acre standard. The value of the parcel is calculated by multiplying the lot size adjustment factor for the subject parcel by the base rate, and by multiplying the result by the acreage size.

**Example:** A .50 acre parcel is located in a neighborhood where the base rate is \$8,000 (per acre). The Acreage Size Adjustment Table indicates that the adjustment factor for .50 acres is 1.50. The value of the parcel is:

$$\$8,000 \times 1.50 \text{ adjustment factor} = \$12,000 \times .50 \text{ acres} = \$6,000$$

### **Valuing Residential Acreage Tracts Using the Front Foot Method**

It is often necessary to value acreage tracts of land using the front foot method of pricing instead of the acreage method of pricing. In particular, the front foot method often is used for tracts less than one acre in size and surrounded by platted lots. The land value in the same neighborhood is not different merely because the legal descriptions of the parcels are inconsistent.

The best way to determine the dimensions of a subject property is to read the deed or inspect a survey of the property. This method is time consuming, but is the most accurate. In those counties where the plat maps are verified to scale, a simple measurement of the property will approximate the measurements to an acceptable level. In either case, if you determine either the frontage or depth for a rectangular parcel in feet, you can determine the other dimension by multiplying the acreage of the parcel by 43,560 (the number of square feet per acre) and dividing the result by the known dimension (in feet).

### **Establishing Base Rates for Residential Acreage Tracts**

To calculate the indicated acreage base rate of small acreage tracts located among platted lots, the assessor must determine the value of the comparable adjoining lots and work backwards. The following examples illustrate this process.

**Example 1:** Neighborhood #4 was platted with lots measuring 60 feet by 120 feet. The established value of these improved lots is \$6,000. Scattered among the platted lots are small acreage tracts of .165 acre. The assessor must determine the lot size of each tract and price each tract using the front foot method. However, for purposes of illustration, the acreage base rate can be calculated.

Calculate the size of the platted lots in acres by first determining the number of square feet in the lot (60 feet x 120 feet = 7,200 square feet). Then, divide the square footage of the lot by the number of square feet in an acre ( $7,200' \div 43,560' = .165$  acre). The acreage tracts are the same size as the platted lots. It is important to make this comparison because the base lot for the neighborhood was established at 60' x 120' or .165 acre. Any acreage tracts above or below this size may need an influence factor adjustment applied to the estimated value.

To establish the acreage base rate, divide the established value of the platted lots by the acreage size adjustment factor for .165 acre, and divide the result by the size of the tract ( $\$6,000 \div 2.32 = \$2,586 \div .165 \text{ acre} = \$15,674$ ). The acreage base rate needed to calculate the \$6,000 estimated value of a .165 acre tract in this neighborhood is \$15,700.

**Example 2:** Neighborhood #5 is at the edge of town. The sizes of the acreage tracts range from .41 acre to .5 acre. The assessing official estimates the range of values for these tracts to be \$10,000 to \$12,000. The assessor establishes the base acreage tract in Neighborhood #5 to be .45 acres. The average value of the tracts is \$11,000. Calculate the acreage base rate by dividing the average value of the tracts by the size adjustment factor for the average size of the tracts, and by dividing the result by the average tract size ( $\$11,000 \div 1.57 = \$7,006 \div .45 \text{ acre} = \$15,570$ ). The acreage base rate for Neighborhood #5 is \$15,600.

### Determining Size Adjustment Factors for Acreage

To determine the size adjustment factor for acreage, perform the following steps:

- STEP 1** Determine the size of the tract.
- STEP 2** In the “Acre” column of the size adjustment table, locate the row corresponding to the actual size of the tract.
- STEP 3** Find the intersection of the selected row and the “Factor” column. Note the number that you find—the size adjustment factor for the tract.

To use the size adjustment factor to calculate the value of a parcel that has a size different from the standard in the area, multiply the acreage base rate by the size adjustment factor to find the acreage adjusted rate. Then multiply the acreage adjusted rate by the acreage size of the tract to find the estimated value of the parcel.

$$\begin{array}{rcccl} \text{Acreage Adjusted} & = & \text{Acreage Base} & \times & \text{Acreage Size Adjustment} \\ \text{Rate} & & \text{Rate} & & \text{Factor} \end{array}$$

$$\text{Estimated Value} = \text{Acreage Adjusted Rate} \times \text{Acreage size}$$

**Example:** The estimated value of a .50 acre parcel located in Neighborhood #5 with a base rate of \$15,600 is

$$\$23,400 = \$15,600 \times 1.50$$

$$\$11,700 = \$23,400 \times .50 \text{ acre}$$

**Table 2-11. Acreage Size Adjustment Table**

**Note:** When applying this table to square footage, convert the square footage into acreage by dividing by 43,560.

Acre	Factor	Acre	Factor	Acre	Factor	Acre	Factor
.05	3.00	.30	1.85	.55	1.44	.80	1.19
.06	2.94	.31	1.83	.56	1.44	.81	1.18
.07	2.88	.32	1.81	.57	1.43	.82	1.17
.08	2.82	.33	1.79	.58	1.43	.83	1.15
.09	2.76	.34	1.77	.59	1.42	.84	1.14
.10	2.70	.35	1.75	.60	1.42	.85	1.13
.11	2.64	.36	1.73	.61	1.42	.86	1.12
.12	2.58	.37	1.71	.62	1.41	.87	1.11
.13	2.52	.38	1.69	.63	1.41	.88	1.10
.14	2.46	.39	1.67	.64	1.40	.89	1.09
.15	2.40	.40	1.65	.65	1.40	.90	1.08
.16	2.36	.41	1.63	.66	1.38	.91	1.07
.17	2.32	.42	1.62	.67	1.37	.92	1.06
.18	2.28	.43	1.60	.68	1.35	.93	1.06
.19	2.24	.44	1.59	.69	1.34	.94	1.06
.20	2.20	.45	1.57	.70	1.32	.95	1.04
.21	2.16	.46	1.55	.71	1.30	.96	1.03
.22	2.12	.47	1.54	.72	1.29	.97	1.02
.23	2.08	.48	1.53	.73	1.28	.98	1.02
.24	2.04	.49	1.51	.74	1.26	.99	1.01
.25	2.00	.50	1.50	.75	1.25	1.00	1.00
.26	1.97	.51	1.49	.76	1.24		
.27	1.94	.52	1.48	.77	1.23		
.28	1.91	.53	1.46	.78	1.21		
.29	1.88	.54	1.45	.79	1.20		

**Example:** A .33 acre tract is located in a neighborhood where 1 acre tracts are valued at \$20,000 per acre. The estimated value of the .33 acre tract is calculated as:  $\$20,000 \times 1.79 = \$35,800 \times .33 \text{ acres} = \$11,814$  or \$11,810.

### **Determining Influence Factors for Residential Acreage**

Influence factors are applied to residential acreage in the same way that they are applied to platted lots. When the assessing official establishes base rates for a neighborhood, the assessor establishes rates for the base acreage tract. The calculated value of this base entity becomes the standard against which all remaining acreage tracts within the neighborhood are compared. Often, there are conditions peculiar to specific tracts within the neighborhood that must be analyzed on an individual basis.

These conditions require the assessor to make an adjustment to the value of the tract. This adjustment is an influence factor.

An influence factor refers to an aspect of a lot's condition that is different from the base lot on which the base unit land value for the subject neighborhood is based. An influence factor requires an adjustment to the estimated value of the lot to account for variations and is expressed as a percentage. The percentage is obtained by comparing the estimated dollar amount of the adjustment to the estimated value of the lot. This ratio is converted to a percentage. If the ratio represents a negative amount, a negative influence factor percentage is applied to the subject land. If the ratio represents a positive amount to the subject, a positive influence factor is applied to the subject's land.

The examples below illustrate how to identify and calculate influence factors for residential acreage.

**Example 1:** Parcel A is a 4 acre parcel with a residential dwelling and a mobile home situated on it. Because there are two dwelling units, the assessor has designated two 1 acre residential homesites for the property. Upon investigation, it is determined that the mobile home has its own septic system, but obtains its water supply from the residential dwelling. Both 1 acre residential sites are priced using a base rate of \$10,000 per acre. An adjustment is necessary to the 1 acre site where the mobile home is located because there is no separate water supply to the mobile home. The amount of the influence factor adjustment equals the dollar amount attributed to water facilities (\$1,000), as established by the assessing official. Therefore, an adjustment of 10% is applied to the 1 acre homesite for the mobile home.

**Example 2:** Area #10 surrounds a lake and contains parcels sized at .30 acre to .50 acre. The base parcel size of the neighborhood is .40 acre. The base rate for Area #10 has been established at \$121,200 per acre. The value of the base lakefront parcel is \$80,000.

$$\$121,200 \times 1.65 \times .40 = \$79,990$$

During the analysis of the sales data, it was realized that the individual parcel size made no significant difference in the market value of the land. Therefore, all individual parcels should have a land value of approximately \$80,000. A .30 acre parcel receives a positive influence factor of +19%.

$$\begin{array}{rclcl} \$121,200 & \times & 1.85 & \times & .30 \text{ acre} & = & \$67,270 \\ & & \$80,000 & \div & \$67,270 & = & 1.189 \text{ or } 1.19 \\ & & 1.19 & - & 1.00 & = & .19 \text{ or } 19\% \end{array}$$

A .50 of an acre parcel receives a negative influence factor of -12%.

$$\begin{array}{rclcl} \$121,200 & \times & 1.50 & \times & .50 \text{ acre} & = & \$90,900 \\ & & \$80,000 & \div & \$90,000 & = & .880 \text{ or } .88 \\ & & .88 & - & 1.00 & = & -.12 \text{ or } -12\% \end{array}$$



### Completing the Land Data and Computations Section of the Property Record Card for Residential Acreage

This section describes how to complete the “Land Data and Computations” section of a residential Property Record Card for residential acreage tracts. The steps describe how to use the acreage method to calculate the value of the acreage. The steps for completing the Property Record Card are grouped into two tasks, described in the sections below:

- Task 1—Record the necessary data for the residential acreage.
- Task 2—Calculate the land value for the residential acreage.

#### Task 1—Recording the Necessary Data

Space is provided on the residential Property Record Card to compute the land value of each residential acreage tract. Enter the data into a series of columns using one row per entry. Enter the one acre residential homesite, if there is one, and the excess acreage as separate entries.

To enter the data for residential acreage, perform these steps:

- STEP 1** In the “Land Type” column, enter the code corresponding to the land type classification of the entry. *Table 2-12* describes the land type options for residential acreage tracts.

**Table 2-12. Land Type Options for Residential Acreage Tracts**

This option	Indicates
9	The amount of land entered in the “Acreage” column is used as a residential homesite.
91	The amount of land entered in the “Acreage” column is classified as residential excess acres.

- STEP 2** In the “Acreage” column, enter the acreage (in acres) for this entry. For parcels of one acre or less and containing a residential dwelling, the entire parcel is designated as a homesite.
- STEP 3** In the “Depth Factor” column, enter the factor used to adjust the base rate or unit value. Instructions for determining the size adjustment factor of a residential acreage tract are provided in the section *Determining Size Adjustment Factor for Acreage* in this chapter. The size adjustment factor is applied to the portion of acreage that is or could be used as a homesite. Acreage identified as excess acreage (over 1.00 acre) does not require a size adjustment factor.
- STEP 4** *If the entry is a residential homesite*, enter the homesite rate as determined by the jurisdiction assessor in the “Base Rate” column.

If the entry is residential excess acreage, enter the excess acre rate as determined by the jurisdiction in the “Base Rate” column.

- STEP 5** In the “Influence Factor” column, indicate any condition peculiar to the acreage tract that requires an adjustment to the estimated value to account for variations from the norm:
- a. Enter the influence code to the left of the brackets.
  - b. Enter the percentage adjustment to the right of the brackets.
  - c. Within the brackets, enter a plus (+) to indicate an increase. Enter a minus (–) to indicate a decrease. **Table 2-13** describes the influence factor codes. Information about determining influence factors is provided in the section ***Determining Influence Factors for Residential Acreage*** in this chapter.

**Table 2-13. Influence Factor Codes for Residential Acreage and Agricultural Homesites**

This code	Indicates
1 Topography	A decrease based on adverse topographical features.
2 Under Improved	A decrease based on the under improvement of landscaping, residential driveways and private walkways, and utility hookups.
3 Excess Frontage	A decrease based on the lower utility value of frontage that is significantly in excess of the base lot frontage.
4 Shape or Size	A decrease based on an irregularity in shape that limits the use of the parcel <b>or</b> a decrease for an oversized lot whose variations are not accounted for elsewhere.  An increase based on an irregularity in shape that enhances the use of the parcel <b>or</b> an increase for an undersized lot whose variations are not accounted for elsewhere.
5 Mis-improvement	A decrease indicating a lot that has been valued higher than its current use. The value must be lowered to the level of comparable properties in the subject neighborhood.
6 Restrictions	A decrease based on encumbrances, restrictive covenants, or obstructions that limit the use of the land.
7 Traffic Flow	A decrease to account for the nuisance of significantly heavier traffic flow that affects the base lot and is not considered in the base lot value.
8 View	A decrease to account for variations in view from the subject lot and not from the base lot that detracts from the subject lot.  An increase to account for variations in view from the subject lot and not from the base lot that enhances the subject lot.

9 Corner Influence	<p>A decrease to account for building restrictions, such as double set backs and increased traffic flow, that detract from the subject lot and are not considered in the base lot value.</p> <p>An increase to account for building restrictions, such as double set backs and increased traffic flow, that offer commercial benefits and are not considered in the base lot value.</p>
O Other	<p>An influence, not described above, such as the following. Describe the factor in the memorandum section.</p> <ul style="list-style-type: none"> <li>■ <b>Golf course</b>—An increase to account for a particular location enhancement, not characteristic of the base lot.</li> <li>■ <b>Water frontage</b>—An increase to account for proximity to a water front, not characteristic of the base lot.</li> <li>■ <b>Cul-de-sac</b>—An increase to account for shape or size enhancements due to a cul-de-sac location, not characteristic of the base lot.</li> <li>■ <b>Location</b>—An increase or decrease to account for the influence of a particular location and not considered in the base lot.</li> <li>■ <b>Soil conditions</b>—A decrease to account for adverse soil conditions that prohibit the subject lot being used the same as the base lot.</li> <li>■ <b>Drainage</b>—A decrease to account for drainage limitations, indicated by standing water, not characteristic of the base lot.</li> <li>■ <b>Flooding susceptibility</b>—A decrease to account for a lot or a portion of a lot being in a flood plain, not characteristic of the base lot.</li> <li>■ <b>Noise nuisance</b>—A decrease to account for extraneous noise or other such nuisances not characteristic of the base lot.</li> <li>■ <b>Excess depth</b>—A decrease to account for a disproportionate frontage depth not accounted for in the size adjustment factor.</li> </ul> <p><b>Limited access</b>—A decrease to account for ingress or egress limitations not characteristic of the base lot.</p>

**STEP 6** Repeat Step 1 through Step 5 for each residential tract entry.

### **Task 2 Calculating the Land Value**

To calculate the land value for the residential acreage, perform these steps:

**STEP 1** Calculate the adjusted rate for the residential acreage tract entry by multiplying the base rate by the size adjustment factor:

$$\text{Adjusted Rate} = \text{Base Rate} \times \text{Size Adjustment Factor}$$

Round the adjusted rate to the nearest \$1.

**STEP 2** Calculate the estimated value of the entry by multiplying the amount of acreage by the adjusted rate:

$$\text{Estimated Value} = \text{Adjusted Rate} \times \text{Amount of Acreage}$$

Round the estimated value to the nearest \$10.

**STEP 3** Calculate the land value of the entry by adjusting the estimated value by the influence factor:

$$\text{Land Value} = \text{Estimated Value} \times (1.00 - \text{Influence Factor Percentage})$$

Round the land value to the nearest \$10.

**Note:** A positive influence factor would be an addition of the influence factor percentage to 1.00. If there is no influence factor, the land value is the same as the Estimated value.

**STEP 4** Perform Step 1 through Step 3 for each residential acreage tract entry.

**Example:** The subject residential parcel has a size of 2.50 acres and contains a dwelling. The parcel has a one acre homesite. The remaining 1.50 acres are considered residential excess acres. This parcel is located in a neighborhood where the homesite base rate is \$10,000 and the residential excess acre base rate is \$2,000 per acre.

- The “Land Type” column designates each portion of the acreage.
- The “Acreage” column indicates the acreage size for each land type.
- The “Factor” column indicates the size adjustment factor for the homesite portion of the lot.
- The assessing official determines the base rate for the neighborhood.
- The adjusted base rate for the homesite acreage is

$$\text{Adjusted Base Rate} = \text{Base Rate} \times \text{Size Adjustment Factor}$$

$$\$10,000 = \$10,000 \times 1.00$$

- The adjusted Base Rate for the residential excess acreage is

$$\text{Adjusted Base Rate} = \text{Base Rate} \times 1.00$$

$$\$2,000 = \$2,000 \times 1.00$$

- The estimated value of the homesite acreage is

$$\text{Estimated Value} = \frac{\text{Adjusted Base Rate}}{\text{Rate}} \times \text{Homesite Acreage}$$

$$\$10,000 = \$10,000 \times 1.00 \text{ acres}$$

- The estimated value of the residential excess acreage is

$$\text{Estimated Value} = \frac{\text{Adjusted Base}}{\text{Rate}} \times \text{Excess Acreage Size}$$

$$\$3,000 = \frac{\$2,000}{1} \times 1.50 \text{ acres}$$

- Since there are no influence factors on the parcels, the land value of each entry is the same as the estimated value.
- The total residential land value for this parcel is the same as the first entry (\$10,000). *In this case the total is considered residential land value because it is less than or equal to one acre.*
- The total non-residential land value for this parcel is the same as the second entry (\$3,000). *In this case the total is considered non-residential land value because it is the amount over 1 acre.*

## **Valuing Commercial and Industrial Land**

The procedure for valuing commercial and industrial acreage tracts is similar to the procedure for other types of land. However, sales information for existing business properties is less reliable and less available. The assessing official must draw on the expertise within the community to establish the basis of valuing these types of tracts. The assessing official must delineate general neighborhood areas on the basis of characteristics that distinguish them from other areas. This delineation is normally based on such characteristics as:

- zoning
- major roads or streets
- natural geographic features like waterways or lakes
- availability of certain modes of transportation.

These neighborhoods are the basis for establishing land values.

## **Understanding Commercial and Industrial Land Categories**

There are four categories of commercial and industrial land described in *Table 2-14*.

**Table 2-14. Categories of Commercial and Industrial Land**

<b>This category</b>	<b>Indicates</b>
Primary	The primary building or plant site. The following are examples of primary land: <ul style="list-style-type: none"> <li>■ land located under buildings</li> <li>■ regularly used parking areas</li> <li>■ roadways</li> <li>■ regularly used yard storage</li> <li>■ necessary support land</li> </ul>
Secondary	Land used for purposes that are secondary to the primary use of the land. The following are examples of secondary land: <ul style="list-style-type: none"> <li>■ parking areas that are not used regularly</li> <li>■ yard storage that is not used regularly</li> </ul>
Usable Undeveloped	The amount of acreage that is vacant and held for future development
Unusable Undeveloped	The amount of vacant acreage that is unusable for commercial or industrial purposes, and not used for agricultural purposes

Normally, large acreage tracts are partitioned to indicate the various uses of the individual tract. Small acreage tracts of one acre or less are often used as a primary building site and require the primary land classification.

The base rate for each use category includes the following items:

- For primary land, the base rate represents the estimated January 1st value of the vacant land and various costs associated with the development of the land. The following developmental costs may be included in the base rate for primary acreage:
  - sanitary sewers
  - storm sewers
  - potable water lines
  - fire prevention lines
  - gas lines
  - septic systems
  - water wells
  - grading for general improvement of the site
  - landscaping.
  
- For secondary land, the base rate represents the January 1st value of the vacant land and the various costs associated with the development of the land. Normally, this acreage does not include developmental costs for water and sewage. The following developmental costs may be included in the base rate for secondary acreage:
  - storm sewers
  - grading for general improvement of the site.
  
- For usable undeveloped land, the base rate represents the January 1st value of vacant or raw land that is zoned for commercial and industrial purposes. This type of land has incurred no on-site development cost. This category does *not* include land utilized for agricultural purposes, as stated in IC 6-1.1-4-13.
  
- For unusable undeveloped land, the base rate represents the January 1st value of undeveloped land that is zoned for commercial or industrial purposes. This type of land has incurred no on-site development costs and normally represents an area of vacant land with restrictions. There may be restrictions against building because there are environmental hazards on the property or because the area has been designated as a wetland area by the federal government. This category does *not* include land that is utilized for agricultural purposes, as stated in IC 6-1.1-4-13.

### **Establishing Use Classes for Commercial and Industrial Properties**

Within each neighborhood, the assessing official may establish broad use classes based on either the current use or probable use of commercial or industrial properties. The identification of broad use classes helps ensure that similar types of properties are analyzed and valued consistently by the assessor. Broad use classes may be identified for apartments, retail stores, offices, or various zoning categories. By determining broad use classes for each neighborhood, the assessor can compare unit values and establish base rates to treat all properties equitably.

The table below shows the recommended unit value for selected use classes.

**Table 2-15. Recommended Unit Values for Selected Use Classes**

<b>For this use class</b>	<b>Use this unit value</b>
Central business district	Front foot or square foot
Urban fringe businesses	Front foot or square foot
Retail or service strip centers	Front foot or square foot
Shopping centers	Square foot or acreage
Interchange areas	Square foot or acreage
Town centers	Front foot or square foot
Suburban office parks	Square foot or acreage
Urban renewal projects	Front foot, square foot, or acreage
Industrial corridors	Front foot or acreage
Industrial parks	Acreage
Rural industrials	Acreage
Apartment complexes	Square foot, acreage, or unit density
Parking accommodations	Front foot, square foot, unit density, or acreage

### **Determining the Building Density Ratio**

For commercial and industrial parcels, the assessor analyzes each individual parcel to determine what portion of the parcel is considered improved and what portion of the parcel is considered undeveloped. Site size refers to the improved portion of the land which may encompass the entire parcel, multiple parcels, or a portion of a parcel.

Commercial and industrial properties contain certain site requirements for each specific property. These site requirements differ from use to use, or within the same use, because of variations in the size of the buildings. For example, a 40,000 square foot store requires more building space and parking area than a comparable store of 20,000 square feet. There is, within each use category, a definite relationship between the building size and the required site size, referred to as building density ratio. This ratio is calculated by dividing the area of the site by the gross floor area of the building. The result is rounded to one decimal point (the nearest tenth).



By analyzing the building density ratios throughout a defined neighborhood, the assessor develops a norm for that area. Each neighborhood could have a different norm based on the properties located within it. By thinking about the development of a community, the assessor can appreciate the need for identifying the different building density ratios associated with a community.

As commercial and industrial areas develop over a period of time, land requirements necessary to support the various businesses change. For years, downtown businesses have relied on limited on-street parking so the commercial structures normally were built to cover the entire area of a lot. As more automobiles clogged the downtown streets, many businesses began moving into recently constructed larger structures at the edge of town. To support these facilities, the owners provided adequate amounts of parking with pleasantly landscaped surroundings on larger tracts of land. These facilities served their purpose well, but as time passed and business patterns change, newer, larger, and more accessible complexes have been constructed to attract the contemporary uses. These complexes occupy large acreage tracts and provide efficient parking facilities, landscaped areas, and/or greenspaces. By analyzing the building density ratios of these various locations, the assessor can establish standards relative to the size requirements required to support the various uses by property use for each neighborhood. Each type of facility located within the area is compared against its established standard to determine the amount of the developed site which should be classified as primary land.

**Example.** An 80,000 square foot strip center occupying a five acre tract would have a building density ratio calculated by dividing 217,800 square feet ( $43,560 \times 5 = 217,800$ ) by the 80,000 square foot building ( $217,800 / 80,000 = 2.72$ , rounded to 2.7). By comparing this ratio to other strip centers ratios in the neighborhood, a standard is established by use category for each neighborhood. Once a standard is established, the assessor can apply it to other strip centers to determine how much of the improved site is to be classified as primary. No portion of the improved site shall be classified as secondary until the requirements of the building density ratio have been met.

Some taxing jurisdictions have an active zoning authority that issues certain building requirements based on the type of property being constructed. Care should be taken when consulting local zoning information during the analysis of a neighborhood's building density ratios. Zoning regulations normally mandate minimum land size and parking requirements which may, but do not necessarily correspond to the developed portions of all land. What is more, these regulations change periodically so an analysis using current regulations might misrepresent the actual situation in a specific neighborhood. It is more applicable to analyze the building sites within each defined neighborhood and develop the building density ratio standards based upon specific information obtained from the analysis.

### Establishing Base Rates for Commercial and Industrial Land

To calculate the indicated base rate of small acreage tracts located among platted lots, the jurisdiction assessor must determine the value of the comparable adjoining lots and work backwards. The following examples illustrate the process of calculating acreage values and square foot values.

**Example 1:** For acreage values, Neighborhood #7 was platted with lots measuring 60 feet by 120 feet. The established value of the improved lots is \$24,000. Scattered among these lots are small acreage tracts of .20 acre. They are slightly larger than the platted lots and reflect a slightly higher estimated value. The acreage rate for the platted lots is calculated by dividing \$24,000 by the factor from the size adjustment table, for the equivalent size of the platted lots. The result is then divided by the acreage equivalent of the platted lots. ( $\$24,000 \div 2.36 = \$10,169 \div .165 \text{ acres} = \$61,630$ ). To calculate the value of the .20 acre parcels, multiply the rate of \$61,630 by the factor from the size adjustment table for .20 acres. Multiply the result by the parcel size.

$$(\$61,630 \times 2.20 = \$135,586 \times .20 \text{ acres} = \$27,117).$$

**Example 2:** For acreage values, Neighborhood #7 is analyzed slightly differently to determine the square foot base rate. The platted lots contain 7,200 square feet and the value of the lots is \$24,000. The square foot base rate is determined by first dividing the value of the lot by the size adjustment factor from the applicable table for the equivalent acreage size. The factor is 2.36 for a parcel size of .165 acres ( $60' \times 120' = 7,200$  square feet). The rate of \$10,169 ( $\$24,000 \div 2.36$ ) is divided by the number of square feet to equal \$1.41 per square foot ( $\$10,169 \div 7200$  square feet = \$1.41). To calculate the value of the .20 acre parcels, multiply the square foot rate of \$1.41 by the factor from the size adjustment table for .20 acres, and multiply the result by the parcel square footage ( $\$1.41 \times 2.20 = \$3.10 \times 8,712$  square feet = \$27,007).

To calculate the indicated value of larger acreage tracts, the assessor may analyze the land using one of the following methods:

- The **land development method** is normally more appropriate for newer commercial or industrial area because on-site development costs are attributed directly to the land using the latest construction costs available. The land development method entails adding the purchase price of vacant land to the on-site development costs. On large acreage tracts, the value of the development costs are attributed to the acres affected by the cost.
- The **comparison method** is more reliable when measuring the effects of location on various commercial and industrial properties. The comparison method compares properties of similar use against properties of compatible use. By establishing a broad range of use classes, such as zoning categories, land-to-

building ratios, and current and probable uses, the assessor develops standards for each neighborhood. The standards determine the basis for comparison between the properties within the neighborhood and other neighborhoods. The assessor applies sales information or written qualified real estate professional estimates to the standards. The use of an appropriate unit value makes values comparable between the various neighborhoods.

### **Determining Influence Factors for Commercial and Industrial Land**

Influence factors are applied to small tracts of commercial and industrial acreage in the same way that they are applied to platted lots. When the assessing official establishes base rates for a neighborhood, the assessor establishes rates for the base acreage tract. The calculated value of this base entity becomes the standard to which all remaining acreage tracts within the neighborhood are compared. Often, there are conditions peculiar to specific tracts within a neighborhood that must be analyzed on an individual basis. These conditions require the assessor to make an adjustment to the value of the tract. This adjustment is an influence factor.

“Influence Factor” refers to a condition peculiar to the lot that dictates an adjustment to the estimated value to account for variations from the base lot on which the base unit land value for the subject neighborhood is predicated. A single digit numeric code is used to indicate the nine most prevalent factors and provide for the application of other (code O) factors not elsewhere coded.

The examples below illustrate how to identify and calculate influence factors for commercial and industrial acreage.

**Example 1:** In a commercial neighborhood, there is a small acreage tract of less than 1 acre that is vacant and is being held for future development. The remaining tracts within the neighborhood are equal in size to the subject and are developed. The vacant small acreage parcel is considered unimproved and a negative influence factor adjustment equivalent to the cost of improving the parcel is applied to the parcel.

**Example 2:** The small acreage commercial tracts located in Neighborhood #32 are similar in size and used for commercial purposes. The base acreage value was established for the neighborhood to reflect the typical tract which is a parcel that has restricted access to the highway due to the small number of crossovers located in the highway. However, parcel Z, located at the intersection of the same highway and a similar highway, has very good access from both roads. The assessing official has determined through the analysis of a sale of a comparable corner tract that parcel Z has a higher value than the tracts used to establish the base value for the area. The assessor determines that a positive influence factor is necessary to adjust parcel Z’s value. The difference between the higher value and the estimated value is expressed as a percentage and applied to parcel Z’s estimated value. The corner influence associated with parcel Z is the reason for assigning this positive influence factor adjustment.

**Note:** The procedures for calculating the front foot base rate and the true tax value of commercial platted lots is identical to the procedures for residential platted lots. Instructions are provided in the section *Completing the Land Data and Computations Section of the Property Record Card for Platted Lots*.

### **Completing the Land Data and Computations Portion of the Property Record Card for Commercial and Industrial Acreage**

This section describes how to complete the “Land Data and Computations” section of a commercial and industrial Property Record Card for commercial or industrial acreage tracts. The steps describe how to use the acreage method to calculate the value of the acreage. The steps for completing the property record card are grouped into two tasks, described in the sections below:

- **Task 1**—Record the necessary data for the lot.
- **Task 2**—Calculate the true tax value for the lot.

**Note:** The procedures for calculating the front foot base rate and the true tax value of commercial platted lots is identical to the procedures for residential platted lots. Instructions are provided in the section *Completing the Land Data and Computations Section of the Property Record Card for Platted Lots* in this chapter.

#### **Task 1—Recording the Necessary Data**

Space is provided on the commercial and industrial Property Record Card to compute the true tax value of platted lots and acreage tracts used for commercial or industrial purposes. Enter the data into a series of columns using one row per entry.

To enter the data for a commercial or industrial acreage, perform these steps:

- STEP 1** In the “Land Type” column, enter the code corresponding to the land type classification of the entry. *Table 2-16* describes the land type options for commercial and industrial acreage tracts.

**Table 2-16. Land Type Options for Commercial and Industrial Acreage Tracts**

<b>This option</b>	<b>Indicates</b>
11	The amount of land entered in the “Acreage” column is classified as commercial or industrial primary land
12	The amount of land entered in the “Acreage” column is classified as commercial or industrial secondary land
13	The amount of land entered in the “Acreage” column is classified as commercial or industrial usable undeveloped land
14	The amount of land entered in the “Acreage” column is classified as commercial or industrial unusable undeveloped land

- STEP 2** In the “Acreage” column, enter the acreage (in acres) designated as each specific land type.
- STEP 3** In the “Depth Factor” column, enter 1.00 as the acreage size adjustment factor for all commercial and industrial acreage tracts of one acre or more. For commercial and industrial acreage tracts of less than one acre, the size adjustment factor is derived by comparing the parcel acreage or square feet size to the Acreage Size Adjustment Table included in *Table 2-11*. This table compares smaller improved tracts of land to an established one acre standard. In the “Acre” column of the size adjustment table, locate the row corresponding to the actual size of the tract. Find the intersection of the selected row and the “Factor” column. Note the number that you find. This is the size adjustment factor for the tract.
- STEP 4** In the “Base Rate” column, enter the acreage value as determined by the assessing official and approved by the Property Tax Assessment Board of Appeals.
- STEP 5** In the “Influence Factor” column, indicate any condition peculiar to the acreage tract that requires an adjustment to the estimated value to account for variations from the norm, if necessary:
- a. Enter the influence code to the left of the brackets.
  - b. Enter the percentage adjustment to the right of the brackets.
  - c. Within the brackets, enter a plus (+) to indicate an increase. Enter a minus (–) to indicate a decrease. *Table 2-17* describes the influence factor codes. Information about determining influence factors is provided in the section *Determining Influence Factors for Commercial and Industrial Land* in this chapter.

**Table 2-17. Influence Factor Codes for Commercial and Industrial Property**

This code	Indicates
1 Topography	A decrease based on adverse topographical features.
2 Under Improved	A decrease based on the under improvement of landscaping, driveways and private walkways, and utility hookups.
3 Excess Frontage	A decrease based on the lower utility value of frontage that is significantly in excess of the base lot frontage.
4 Shape or Size	A decrease based on an irregularity in shape that limits the use of the parcel <b>or</b> a decrease for an oversized lot whose variations are not accounted for elsewhere.  An increase based on an irregularity in shape that enhances the use of the parcel <b>or</b> an increase for an undersized lot whose variations are not accounted for elsewhere.

5 Mis-improvement	A decrease indicating a lot that has been valued higher than its current use. The value must be lowered to the level of comparable properties in the subject neighborhood.
6 Restrictions	A decrease based on encumbrances, restrictive covenants, or obstructions that limit the use of the land.
7 Traffic Flow	A decrease to account for the nuisance of significantly heavier traffic flow that affects the base lot and is not considered in the base lot value.
8 View	<p>A decrease to account for variations in view from the subject lot and not from the base lot that detracts from the subject lot.</p> <p>An increase to account for variations in view from the subject lot and not from the base lot that enhances the subject lot.</p>
9 Corner Influence	<p>A decrease to account for building restrictions, such as double set backs and increased traffic flow, that detract from the subject lot and are not considered in the base lot value.</p> <p>An increase to account for building restrictions, such as double set backs and increased traffic flow, that offer commercial benefits and are not considered in the base lot value.</p>
O Other	<p>An influence, not described above, such as the following. Describe the factor in the memorandum section.</p> <ul style="list-style-type: none"> <li>■ <b>Golf course</b>—An increase to account for a particular location enhancement, not characteristic of the base lot.</li> <li>■ <b>Water frontage</b>—An increase to account for proximity to a water front, not characteristic of the base lot.</li> <li>■ <b>Cul-de-sac</b>—An increase to account for shape or size enhancements due to a cul-de-sac location, not characteristic of the base lot.</li> <li>■ <b>Location</b>—An increase or decrease to account for the influence of a particular location and not considered in the base lot.</li> <li>■ <b>Soil conditions</b>—A decrease to account for adverse soil conditions that prohibit the subject lot being used the same as the base lot.</li> <li>■ <b>Drainage</b>—A decrease to account for drainage limitations, indicated by standing water, not characteristic of the base lot.</li> <li>■ <b>Flooding susceptibility</b>—A decrease to account for a lot or a portion of a lot being in a flood plain, not characteristic of the base lot.</li> <li>■ <b>Noise nuisance</b>—A decrease to account for extraneous noise or other such nuisances not characteristic of the base lot.</li> <li>■ <b>Excess depth</b>—A decrease to account for a disproportionate frontage depth not accounted for in the size adjustment factor.</li> <li>■ <b>Limited access</b>—A decrease to account for ingress or egress limitations not characteristic of the base lot.</li> </ul>

**STEP 6** Repeat Step 1 through Step 5 for each commercial or industrial acreage tract entry.

### **Task 2: Calculating the True Tax Value**

To calculate the true tax value for the commercial or industrial acreage, perform these steps:

**STEP 1** Calculate the adjusted rate for the commercial or industrial acreage tract entry by multiplying the base rate by the size adjustment factor:

$$\text{Adjusted Rate} = \text{Base Rate} \times \text{Size Adjustment Factor}$$

Round the adjusted rate to the nearest \$1.

**STEP 2** Calculate the estimated value of the entry by multiplying the acreage or square footage by the adjusted rate:

$$\text{Estimated Value} = \text{Adjusted Rate} \times \text{Acreage or Square Footage}$$

Round the estimated value to the nearest \$10.

**STEP 3** Calculate the true tax value of the entry by adjusting the estimated value by the influence factor:

$$\text{True Tax Value} = \text{Estimated Value} \times (1.00 - \text{Influence Factor Percentage})$$

Round the true tax value to the nearest \$10.

**Note:** A positive influence factor would be an addition to the influence factor percentage of 1.00. If there is no influence factor, the true tax value is the same as the estimated value.

**STEP 4** Perform Step 1 through Step 3 for each commercial and industrial acreage entry.

**Example 1:** A small acreage parcel of .74 acres is developed with a commercial business. The acreage base rate for the neighborhood has been established at \$120,000 per acre.

- The size adjustment factor for .74 acres is 1.26.
- The assessing official determines the base rate for the neighborhood to be \$120,000.

- The adjusted base rate for the parcel is:

$$\begin{aligned}\text{Adjusted Base Rate} &= \text{Base Rate} \times \text{Size Adjustment Factor} \\ \$151,200 &= \$120,000 \times 1.26\end{aligned}$$

- The estimated value of the acreage is

$$\begin{aligned}\text{Estimated Value} &= \text{Adjusted Base Rate} \times \text{Acreage Size} \\ \$111,890 &= \$151,200 \times .74\end{aligned}$$

**Example 2:** A 10-acre industrial parcel contains a small manufacturing facility. The parcel has six acres designated as primary land and four acres designated as undeveloped usable land. The average base rate for this industrial neighborhood is \$25,000 per acre for the primary land and \$20,000 per acre for the undeveloped usable land.

- The base rates are
- \$25,000 for the primary land
- \$20,000 for the undeveloped usable land
- The adjusted base rates are:

$$\begin{aligned}\text{Adjusted Base Rate} &= \text{Base Rate} \times \text{Size Adjustment Factor} \\ \text{Primary} &= \$25,000 = \$25,000 \times 1.00 \\ \text{Undeveloped Usable} &= \$20,000 = \$20,000 \times 1.00\end{aligned}$$

- The estimated values are:

$$\begin{aligned}\text{Estimated Value} &= \text{Adjusted Base Rate} \times \text{Acreage Size} \\ \text{Primary} &= \$150,000 = \$25,000 \times 6 \text{ acres} \\ \text{Undeveloped Usable} &= \$80,000 = \$20,000 \times 4 \text{ acres}\end{aligned}$$

## Valuing Agricultural Land

The agricultural land assessment formula involves the identification of agricultural tracts using data from detailed soil maps, aerial photography, and local plat maps. Each variable in the land assessment formula is measured using appropriate devices to determine its size and effect on the parcel's assessment. Uniformity is maintained in the assessment of agricultural land through the proper use of soil maps, interpreted data, and unit values.

In order to apply the agricultural land assessment formula, you need to understand the following topics, which are discussed in the sections below:

- agricultural land base rate values
- assessment of agricultural land



- units of measurement for agricultural land
- classification of agricultural land into land use types
- use of soil maps
- calculating the soil productivity index
- valuation of strip mined agricultural land
- valuation of oil and gas interests

### **Agricultural Land Base Rate Value**

---

The 2019 general reassessment agricultural land value utilizes the land's current market value, which is based on the productive capacity of the land, regardless of the land's potential or highest and best use. The most frequently used valuation method for use-value assessment is the income capitalization approach. In this approach, use-value is based on the residual or net income that will accrue to the land from agricultural production.

As illustrated in the following equation, the market value of agricultural land is calculated by dividing the net income of each acre by the appropriate capitalization rate.

$$\text{Market value} = \text{Net Income} \div \text{Capitalization Rate}$$

The net income of agricultural land can be based on either the net operating income or the net cash rent. Net operating income is the gross income received from the sale of crops less the variable costs (i.e. seed and fertilizer) and fixed costs (i.e. machinery, labor, property taxes) of producing crops. The net cash rent income is the gross cash rent of an acre of farmland less the property taxes on the acre. Both methods assume the net income will continue to be earned into perpetuity.

The capitalization rate converts the net income into an estimate of value. The capitalization rate reflects, in percentage terms, the annual income relative to the value of an asset; in this case agricultural land. Conceptually, this capitalization rate incorporates the required returns to various forms of capital, associated risks, and the anticipated changes over time.

Since agricultural land in Indiana is nearly evenly divided between cash rent and owner-occupied production, the Department utilized a six-year rolling average of both methods in determining the market value of agricultural land. The capitalization rate applied to both types of net income was based on the annual average interest rate on agricultural real estate and operating loans in Indiana for this same period. The table below summarizes the data used in developing the average market value.

Table 2-18 Agricultural Land Value

Year	NET INCOMES			MARKET VALUE IN USE		
	Cash Rent	Operating	Cap. Rate	Cash Rent	Operating	Average
2013	204	341	8.00%	2,550	4,263	3,406
2014	205	171	8.00%	2,563	2,138	2,350
2015	198	-39	8.00%	2,475	-488	994
2016	173	75	8.00%	2,163	938	1,550
2017	175	30	8.00%	2,188	375	1,281
2018	181	79	8.00%	2,263	988	1,625

### Assessing Agricultural Land

The agricultural land assessment formula involves identifying agricultural tracts using data from a detailed soil map, aerial photography, and local plat maps. Each variable of the land assessment formula is measured using various devices to determine its size and effect on the parcel's assessment. The proper use of the soil maps, interpreted data, and unit values results in greater uniformity in the assessment process of agricultural lands.

Indiana Code section 6-1.1-4-13(a) declares, “**In assessing or reassessing land, the land shall be assessed as agricultural land *only when it is devoted to agricultural use***” [emphasis added]. Indiana Code section 6-1.1-4-13(e) states, “This section does not apply to land purchased for industrial or commercial uses.”

Pursuant to Indiana Code section 6-1.1-4-13, land “devoted to agricultural use” shall be assessed as agricultural land. However, land “*purchased for*” an industrial or commercial uses shall not be assessed as agricultural land. Additionally, all land *utilized* for agricultural purposes is valued as agricultural land -- using a statewide base rate and a soil productivity index system. Unless provided elsewhere in the law, the Manual, or Guidelines, the parcel's size does not determine the property classification or pricing method for the parcel. Rather, the property classification and pricing method are determined by the property's use or zoning. For example, some commercial and industrial zoned acreage tracts devote a portion of the parcel to an agricultural use. The assessing official must classify these parcels as either commercial or industrial. However, the portions of land devoted to agricultural use are to be valued using the agricultural land assessment formula. Portions not used for agricultural purposes are to be valued using the commercial and industrial acreage guidelines. To illustrate:

- (1) A major industrial corporation purchased a 40 acre cornfield to locate a corn processing facility in Indiana. After undergoing the local zoning process, the entire parcel was re-zoned from agricultural zoning to industrial zoning. The corporation has utilized 15 acres of the parcel by constructing a manufacturing and warehouse facility with the idea that the remaining 25 acres would be

available for future expansion, if necessary. The 25 acres in reserve is currently being cash rented to a local agricultural producer, who row-crops the acreage.

*Conclusion:* The assessor should assign a property classification of 310 - Food and Drink Processing Facility - to the 40 acre parcel. The 15 acre portion of the acreage that is utilized for industrial purposes should be assigned land use codes representing the industrial acreage base rates for that particular area of the jurisdiction. The 25 acre portion of the parcel that is being row-cropped by the local farmer should be priced using the agricultural productivity method of pricing. The 25 acres would have the soil types delineated by soil type, have each type soil analyzed for its land cover class, and have its assessment calculated using the agricultural base rate.

(2) The ACME Development Company purchased a 30 acre parcel of land that was being used for agricultural purposes. ACME appeared before the local zoning officials and received a zoning change for the front 10 acres as to be commercial retail, and the rear 20 acres, which has access from an adjoining state highway, was zoned for a commercial office. ACME immediately began constructing a retail shopping complex on the front 10 acres of the parcel. The 20 acres is being cash rented to a local farmer, but is offered for sale by a local real estate broker.

*Conclusion:* The 30 acre parcel should have a property class designation of 326 -- Neighborhood Shopping Center assigned to it. The front 10 acre commercial portion of the parcel should be valued using the commercial acreage base rate for this area of the jurisdiction. The rear 20 acres that is being farmed should be priced using the agricultural productivity method of pricing. The 20 acres should have the soil types delineated by soil type, have each type soil analyzed for its land cover class, and have its assessment calculated using the agricultural base rate for that particular year.

(3) The Good Development (GDC) purchased a 20 acre parcel that was being used for agricultural purposes and had a property class code of 100 – Vacant land. The agricultural productivity method of calculating an assessment valued the parcel at \$22,800 at the time of the purchase in October 2018. GDC purchased the land for the purpose of platting and developing a 40 lot residential subdivision. Once the local Area Planning Commission granted approval for the subdivision and changed the zoning from agricultural to residential, GDC did all the necessary paperwork and filed the plat with the county recorder's office in February 2008.

*Conclusion:* For January 1, 2019, the county auditor follows Indiana Code section 6-1.1-5-3 and assigns parcel numbers to the 40 lots indicated on the plat of the subdivision and notifies the assessing official that the 20 acre parcel has become 40 lots, which need to be assessed for January 1, 2019. The assessing official acknowledges that GDC is the developer by reviewing the plat and, based

on Indiana Code section 6-1.1-4-12(i), knows that the overall assessment cannot be increased because the acreage has become 40 platted lots. However, the agricultural base rate within the agricultural productivity formula has increased from \$1,140 to \$1,200 for January 1, 2019. Before removing the 20 acre parcel from the computer system, the assessor recalculates an assessment for that parcel using the new 2008 rate of \$1,200. The True Tax Value for this particular 20 acre parcel would equal \$24,000, if not platted into the 40 lots. Based on the language of Indiana Code section 6-1.1-4-12(i), each of the 40 parcels would have an assessed value of \$600 ( $\$24,000 / 40 \text{ lots} = \$600 \text{ per lot}$ ). The application of this True Tax Value can be achieved in either of two ways:

- (a) a flat value amount of \$600 can be applied to each of the 40 property record cards; or
- (b) the assessing official can calculate the assessment by determining the lots size of each parcel, applying a front foot or acreage base rate that calculates the applicable 2019 value of improved land in the extended value area of the land summary section of the property record card, and granting influence factor adjustments to each parcel that makes the value of each parcel equal to \$600 per lot.

Land purchased and used for an agricultural purpose qualifies for all land use types associated with the agricultural classification and agricultural soil productivity method of pricing. This includes cropland or pasture land (i.e., tillable land) as well as woodlands

Indiana Code section 6-1.1-4-12 states that if land assessed on an acreage basis (i.e., agricultural land) is subdivided into lots; or land is rezoned for, or put to, a different use, the land shall be reassessed on the basis of its new classification. If improvements are added to real property, the improvements shall be assessed. Such an assessment or reassessment is effective on the next assessment date. For example, a corporation that purchased farmland, subdivided it into residential lots, and sold all but one lot, retaining ownership and converting that vacant lot into an income-producing shopping center, was not entitled to retain the lot's agricultural classification for property tax purposes. The land was properly re-classified from "agricultural" to "commercial" to reflect the land's change in use. *See Aboite Corp. v. State Bd. of Tax Com'rs*, 762 N.E.2d 254 (Ind. Tax Ct. 2001); *see also Howser Development LLC v. Vienna Twp Assessor*, 833 N.E.2d 1108 (Ind. Tax Ct. 2005).

However, Indiana Code section 6-1.1-4-12(i) and (j), added by Public Law 154-2006, clarifies the "developer's discount" for assessments. The "developer's discount" is designed to encourage developers to buy farmland, subdivide into lots, and resell the lots. A lot, or a tract that has not been subdivided into lots, to which a land developer holds title in the ordinary course of its business, may *not* be reassessed until the next assessment date following the earliest of:

- (1) the date on which title to the land is transferred by the land developer (or successor land developer) to a person that is not a land developer; or
- (2) the date on which construction of a structure begins on the land; or
- (3) the date on which a building permit is issued for construction of a building or structure on the land.

The “developer’s discount” applies regardless of whether the lot or tract is rezoned while a land developer holds title to the land. Thus, until one of the aforementioned events occurs, the land developer “reaps the benefit” of the lower agricultural land assessment.

Therefore, the controlling factors that determine whether land is to be assessed as agricultural land are whether the land was purchased for a non-agricultural use, and whether the land is currently used or zoned for an agricultural purpose; however, in some instances, the “developer’s discount” may apply and reassessment of the land may not occur until transfer of title to a non-developer, the start of construction of a building, or the issuance of a construction permit.

The definition of “agricultural land” provides ample basis for the vast majority of assessor decisions. These guidelines were adopted as directed in IC 6-1.1-4-13(d) and incorporated by reference into 50 IAC 2.4-1-2.

#### **IC 6-1.1-4-13**

##### **Agricultural land; assessment**

**Sec. 13. (a)** In assessing or reassessing land, the land shall be assessed as agricultural land only when it is devoted to agricultural use.

**(b)** For purposes of this section, and in addition to any other land considered devoted to agricultural use, any:

- (1) land enrolled in:
  - (A) a land conservation or reserve program administered by the United States Department of Agriculture;
  - (B) a land conservation program administered by the United States Department of Agriculture's Farm Service Agency; or
  - (C) a conservation reserve program or agricultural easement program administered by the United States Department of Agriculture's National Resources Conservation Service;
- (2) land enrolled in the department of natural resources' classified forest and wildlands program (or any similar or successor program);
- (3) land classified in the category of other agriculture use, as provided in the department of local government finance's real property assessment guidelines; or
- (4) land devoted to the harvesting of hardwood timber;

is considered to be devoted to agricultural use. Agricultural use for purposes of this section includes but is not limited to the uses included in the definition of

“agricultural use” in IC 36-7-4-616(b), such as the production of livestock or livestock products, commercial aquaculture, equine or equine products, land designated as a conservation reserve plan, pastureland, poultry or poultry products, horticultural or nursery stock, fruit, vegetables, forage, grains, timber, trees, bees and apiary products, tobacco, other agricultural crops, general farming operation purposes, native timber lands, or land that lays fallow. Agricultural use may not be determined by the size of a parcel or size of a part of the parcel. This subsection does not affect the assessment of any real property assessed under IC 6-1.1-6 (assessment of certain forest lands), IC 6-1.1-6.2 (assessment of certain windbreaks), or IC 6-1.1-6.7 (assessment of filter strips).

(c) The department of local government finance shall give written notice to each county assessor of:

(1) the availability of the United States Department of Agriculture's soil survey data; and

(2) the appropriate soil productivity factor for each type or classification of soil shown on the United States Department of Agriculture's soil survey map.

All assessing officials and the property tax assessment board of appeals shall use the data in determining the true tax value of agricultural land. However, notwithstanding the availability of new soil productivity factors and the department of local government finance's notice of the appropriate soil productivity factor for each type or classification of soil shown on the United States Department of Agriculture's soil survey map for the March 1, 2012, assessment date, the soil productivity factors used for the March 1, 2011, assessment date shall be used for the January 1, 2016, assessment date and each assessment date thereafter.

(d) The department of local government finance shall by rule provide for the method for determining the true tax value of each parcel of agricultural land.

(e) This section does not apply to land purchased for industrial or commercial uses.

There is a subtle distinction between residential acreage tracts and land valued using the agricultural soil productivity method. The basis for this distinction is the different valuation methods used to determine land value for the two types of land. “Agricultural land” is valued using a statewide base rate and a soil productivity index system. All land utilized for agricultural purposes is valued in this manner. “Residential land” is land that is utilized or zoned for residential purposes.

### Other References

a. Assessors are further directed that all acres enrolled in programs of the United States Department of Agriculture (USDA), Farm Services Agency, and Natural Resources Conservation Service and have received a “farm number” are eligible for classification as “agricultural.” Those acres have been determined by those administering federal programs to be a part of an “agricultural operation.” This applies to non-homestead acreage.

- b.** As further evidence of the proper classification of woodlands as agricultural land, the Indiana State Department of Agriculture (ISDA) considers the growing of timber as an agricultural activity by identifying the need to “increase Indiana’s competitiveness in the hardwood sector” as one of its eight major strategies. The Department’s practices and rules support the assertion that the growing of timber is a viable Indiana agricultural crop and should be assessed as such.
- c.** The Department recognizes that certain circumstances may blur the line between the residential property class designation and the agricultural designation when wooded areas are involved. In the preparation of this memorandum, the Department has consulted with the Department of Natural Resources (DNR). The DNR monitors Indiana’s timberland and classified forest programs. In its implementation of the Classified Forest and Wildland Certification Program authorized in IC 6-1.1-6, participating woodland owners with 10 acres or more automatically qualify for the American Tree Farm System’s certification benefits, which include marketing the forest’s products as “green certified.” The Classified Forest and Wildland Program materials also state that timber harvest is not required to qualify for the classification program. The Department believes that the guidelines used for the classified program are applicable when distinguishing agricultural use from non-agricultural use, but other agricultural uses may qualify a parcel for the productivity method of valuation.

### Parcel Size

As stated above, the issue of parcel size has no bearing on the appropriate classification or pricing method of agricultural land, whether the parcel is wooded or used for other agricultural activities.

### Other Agricultural Uses

- a.** A 40 acre parcel, which at one time was a small farm, has since become a mixture of small, scattered trees and brush with less than 50% canopy cover. The assessor classified this parcel as residential excess acreage; the effect of which created a higher assessed value and tax burden than the agricultural soil productivity method.

*Conclusion:* The current owner purchased the parcel as an agricultural property many years ago. The land is currently uncultivated or fallow, but has not changed use nor been re-zoned. This parcel should continue to be classified as agricultural as it was purchased for agricultural use and is used as “non-tillable land” as defined in the *Guidelines*.

- b.** A five acre parcel has a one acre homesite and cattle grazing on the remaining four acres. The assessor classified the four acres using the residential excess acreage rate and refuses to acknowledge the presence of grazing cattle as an agricultural activity because the parcel is less than 10 acres. The county has an

unofficial policy of denying agricultural classification to parcels of less than 10 acres.

*Conclusion:* The grazing of cattle is an agricultural activity; thus, the parcel should be assessed using the agricultural productivity method as it meets the definition of “agricultural operation” in IC 32-30-6-1 and in the *Guidelines*, which define agricultural “tillable land” as land used “for cropland or pasture that has no impediments to routine tillage.” The size of the parcel has no bearing on the determination of agricultural classification.

c. A five acre parcel has a one acre home site and the remaining four acres is devoted to hay production. The county classified the hay field using the residential excess acre rate. The owner has a signed statement from a neighboring dairy farmer that the neighbor harvests the hay from the field for his cattle.

*Conclusion:* The acreage meets the criteria of agricultural “tillable land” as defined in the *Guidelines*. The four acres should be priced using the agricultural soil productivity method. The size of the parcel has no bearing on the determination of agricultural classification.



**Converting Units of Measurement for Agricultural Land**

Figure 2-14 shows the units of measurement commonly used to measure agricultural land. Table 2-19 describes equivalencies for these units of measurement

**SECTION OF LAND/MEAS**

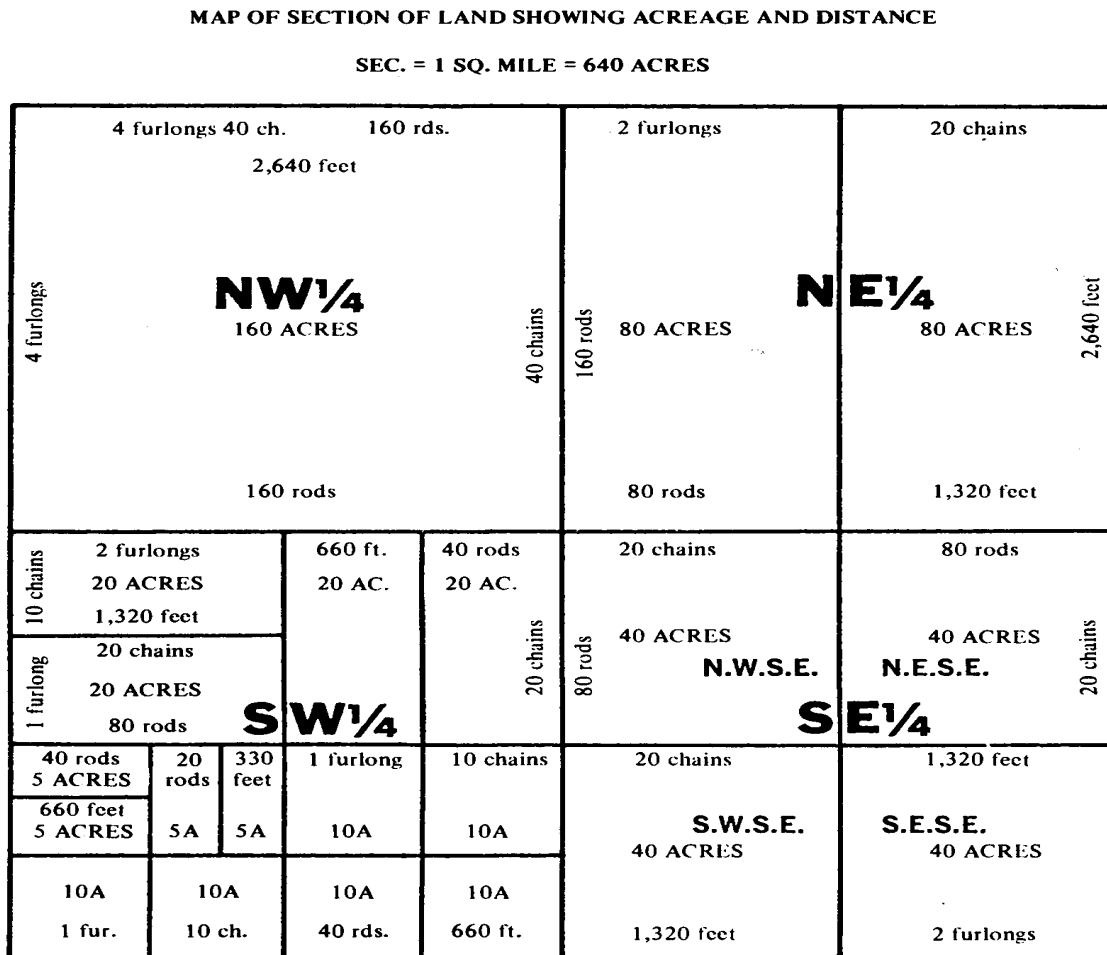

1 MILE = 8 FURLONGS

320 RODS = 5,280 FEET

1 LINK = 7.92 inches  
1 FOOT = 12 inches

1 SQUARE FOOT = 144 sq. inches  
1 SQUARE YARD = 9 sq. feet

1 YARD = 36 in. or 3 ft.

1 SQUARE ROD = 272.25 sq. feet  
30.25 sq. yards

1 ROD OR POLE = 16.5 ft.  
5.5 yds.  
25 links

1 ACRE = 43,560 sq. feet  
160 sq. rods  
10 sq. chains

1 CHAIN = 66 ft.  
100 links  
4 rods

1 ACRE is about 208.7 ft. sq. or 8 rods wide by 20 rods long or any two numbers of rods whose product is 160 (25 x 125 ft.) = .0717 of an acre.

1 FURLONG = 40 rods  
660 ft.

1 SQUARE MILE OR  
1 SECTION EQUALS 640 ACRES

1 MILE = 5,280 ft.  
320 rods  
80 chains  
8 furlongs

1 TOWNSHIP = 36 sq. miles  
OR 36 sections

1 TOWNSHIP = 6 MILES SQ.

Figure 2-14. Example of Agricultural Land Measurements

**Table 2-19. Agricultural Land Measurement Equivalencies**

<b>This linear measurement</b>	<b>Equals</b>	<b>This area measurement</b>	<b>Equals</b>
1 link	7.92 inches	1 sq. foot	144 sq. inches
1 foot	12 inches	1 sq. yard	9 sq. feet
1 yard	36 inches 3 feet	1 sq. rod	272.25 sq. feet 30.25 sq. yards
1 rod or 1 pole	25 links 16.5 feet 5.5 yards	1 acre	43, 560 sq. feet 160 sq. rods 10 sq. chains
1 chain	100 links 4 rods 16.5 feet	1 sq. mile or 1 section	640 acres
1 furlong	40 rods 660 feet	1 jurisdiction	36 sq. miles 36 sections
1 mile	320 rods 80 chains 8 furlongs 5,280 feet		

**Note:** One acre is equivalent to an area of about 208.7 feet by 208.7 feet, 8 rods by 20 rods, or X rods by Y rods where  $X \times Y = 160$ . One jurisdiction is equivalent to an area of 6 miles by 6 miles.

### **Classifying Agricultural Land into Land Use Types**

Agricultural land is categorized according to its land use type and soil identification. The following land use types, described in the sections below, apply to agricultural acreage:

- **Type 2**—Classified Land
- **Type 4**—Tillable Land
- **Type 5**—Nontillable Land
- **Type 6**—Woodland
- **Type 7**—Other Farmland
- **Type 8**—Agricultural Support Land
- **Type 9**—Homesite

**Note:** Agricultural land use types usually are measured from aerial photographs.

#### **TYPE 2—CLASSIFIED LAND**

Classified land is land that has been applied for and approved for specific programs administered by the Indiana Department of Natural Resources (DNR) or the county

surveyor. A 100% influence factor deduction applies to classified land. The following table describes the subtypes of classified land.

**Table 2-20. Classified Land Subtypes**

This subtype	Indicates
Type 21	Classified Forest
Type 22	Wildlife Habitat
Type 24	Windbreak
Type 25	Filter Strip

Pursuant to Indiana Code section 6-1.1-6-6, **forest land** and other land may be classified and assessed if the land satisfies the conditions prescribed for classification as native forest land, a forest plantation, or wildlands.

Land may be classified as a forest plantation if it is cleared land which has growing on it a good stand of timber producing trees as that concept is understood by a district forester or a professional forester. A new forest plantation must have at least four hundred (400) timber producing trees per acre. The trees may be any size but must be well established.

Land may be classified as **wildlands** if it contains one (1) or more of the following:

- (1) Grasslands that are dominated by native grasses or intermixed with other native herbaceous vegetation.
- (2) Wetlands that support a prevalence of native vegetation adapted for saturated conditions.
- (3) Early forest successional stands that are dominated by native herbaceous and woody vegetation that will develop into native forest land.
- (4) Other lands the department determines is capable of supporting wildlife and conducive to wildlife management.
- (5) A body of water.

Land may be classified as **native forest land** if it contains at least forty (40) square feet of basal area per acre or at least one thousand (1,000) timber producing trees, of any size, per acre.

A parcel of land may not be classified as **native forest land, a forest plantation, or wildlands** unless it contains at least ten (10) contiguous acres. The parcel may be of any shape but must be at least fifty (50) feet in width.

A parcel of land may not be classified as **native forest land, a forest plantation, or wildlands** if a dwelling or other building is situated on the parcel. A parcel of land may not be classified as native forest land, a forest plantation, or wildlands if it is grazed by domestic animals or confined nondomesticated animals.

Land classified as **native forest land, a forest plantation, or wildlands** shall be assessed as follows:

(1) At thirteen dollars and twenty-nine cents (\$13.29) per acre for general property taxation purposes, for the January 1, 2017 assessment date.

(2) At the amount per acre determined in the following STEPS for general property taxation purposes, for an assessment date after January 1, 2017:

**STEP ONE:** Determine the amount per acre under this section for the immediately preceding assessment date.

**STEP TWO:** Multiply the STEP ONE amount by the result of:

(A) one (1); plus

(B) the annual percentage change in the Consumer Price Index for All Urban Consumers published by the federal Bureau of Labor Statistics for the calendar year preceding the calendar year before the assessment date.

If any oil, gas, stone, coal, or other mineral is obtained from land which is classified as native forest land, a forest plantation, or wildlands, the parcel shall immediately be assessed for the oil, gas, stone, coal, or other mineral wealth. The assessed value of the mineral wealth shall then be placed on the tax duplicate.

Pursuant to Indiana Code section 6-1.1-6.2-3, a parcel of land may be classified as a **windbreak** if:

- (1) it abuts a fence line or a property line;
- (2) it abuts arable land;
- (3) the landowner enters into an agreement with the department of natural resources establishing standards of windbreak management for the parcel of land as that concept is understood by competent professional foresters;
- (4) it is at least fifty (50) feet wide;
- (5) it does not contain a dwelling or other usable building; and
- (6) no part of it lies within a licensed shooting preserve.

Land that is classified as a **windbreak** shall be assessed as follows:

(1) At thirteen dollars and twenty-nine cents (\$13.29) per acre for general property taxation purposes, for the January 1, 2017 assessment date.

(2) At the amount per acre determined in the following STEPS for general property taxation purposes, for an assessment date after January 1, 2017:

**STEP ONE:** Determine the amount per acre under this section for the immediately preceding assessment date.

**STEP TWO:** Multiply the STEP ONE amount by the result of:

(A) one (1); plus

(B) the annual percentage in the Consumer Price Index for All Urban Consumers published by the federal Bureau of Labor Statistics for the calendar year preceding the calendar year before the assessment date.

However, ditch assessments on the classified land shall be paid. If any oil, gas, stone, coal, or other mineral is obtained from land that is classified as a windbreak, the parcel shall immediately be assessed for the oil, gas, stone, coal, or other mineral wealth. The assessed value of the mineral wealth shall then be placed on the tax duplicate.

In accordance with IC 6-1.1-6.7-1, **filter strip** refers to a strip or an area of vegetation for removing sediment, organic matter and other pollutants from runoff and wastewater. A parcel of land may be classified as a filter strip if the parcel of land meets all of the following requirements:

- (1) The parcel of land is adjacent to an:
  - (A) open water course such as a ditch, creek, or river; or
  - (B) open body of water such as a wetland or lake.
- (2) The parcel of land is at least twenty (20) feet wide but not more than seventy-five (75) feet wide.
- (3) The parcel of land does not contain a dwelling or other usable building.
- (4) The parcel of land is not used for livestock grazing.
- (5) No part of the parcel of land lies within a licensed shooting preserve.
- (6) The landowner enters into an agreement with the:
  - (A) drainage board of jurisdiction along regulated drains; and
  - (B) county surveyor along nonregulated drains;with concurrence of the local soil and water conservation district offices.

Land that is classified as a **filter strip** shall be assessed as follows:

- (1) At thirteen dollars and twenty-nine cents (\$13.29) per acre for general property taxation purposes, for the January 1, 2017 assessment date.
- (2) At the amount per acre determined in the following STEPS for general property taxation purposes, for an assessment date after January 1, 2017:

**STEP ONE:** Determine the amount per acre under this section for the immediately preceding assessment date.

**STEP TWO:** Multiply the STEP ONE amount by the result of:

- (A) one (1); plus
- (B) the annual percentage change in the Consumer Price Index for All Urban Consumers published by the federal Bureau of Labor Statistics for the calendar year preceding the calendar year before the assessment date.

However, ditch assessments on the classified land shall be paid. If any oil, gas, stone, coal, or other mineral is obtained from land that is classified as a filter strip, the parcel shall immediately be assessed for the oil, gas, stone, coal, or other mineral wealth. The assessed value of the mineral wealth shall then be placed on the tax duplicate.

#### **TYPE 4—TILLABLE LAND**

Tillable land is land used for cropland or pasture that has no impediments to routine tillage. Cropland is:

- land used for production of grain or horticultural crops such as:
  - corn
  - soybeans
  - wheat
  - rotation pasture
  - hay
  - vegetables
  - orchard crops
- land used for cover crops
- land in summer fallow
- idle cropland
- land used for Christmas tree plantations
- land used for nursery plantings.

If tillable land is classified as farmed wetlands or experiences flooding from a nearby river or stream causing substantial damage or loss of crops between April and November, it is classified by subtype. The table below describes the subtypes of tillable land.

**Table 2-21. Tillable Land Subtypes**

<b>This subtype</b>	<b>Indicates</b>
Type 41	Land flooded occasionally—damaging floods occur two to four times in a ten-year period. A 30% influence factor deduction applies to this land use type.
Type 42	Land flooded severely—damaging floods occur five times or more in a ten-year period. A 50% influence factor deduction applies to this land use type.
Type 43	Farmed wetlands—land that the U.S. Department of Agriculture has designated as farmed wetlands. This land type applies only to areas of contiguous land measuring 2.5 acres or more. This land use type must be verified through records obtained from the U.S. Department of Agriculture, Farm Service Agency. A 50% influence factor deduction applies to this land use type.

**TYPE 5—NONTILLABLE LAND**

Nontillable land is land covered with brush or scattered trees with less than 50% canopy cover, or permanent pasture land with natural impediments that deter the use of the land for crop production. A 60% influence factor deduction applies to nontillable land.

**TYPE 6—WOODLAND**

Woodland is land supporting trees capable of producing timber or other wood products. This land has 50% or more canopy cover or is a permanently planted reforested area. This land use type includes land accepted and certified by the Indiana Department of Natural Resources (DNR) as forest plantation under guidelines established to minimize soil erosion. An 80% influence factor deduction applies to woodland.

A wooded parcel of land less than 10 acres may be assessed using the agricultural soil productivity method upon evidence of timber production or other agricultural use. In addition, smaller than 10 acre parcels not contiguous with other wooded parcels under the same ownership may qualify as “agricultural.” Of assistance to the assessor in determining the classification is evidence of enrollment in programs which assign a “farm number” or programs designed to foster timber production management. The determining factors are provided in Indiana Code section 6-1.1-4-13, the Manual, and Guidelines. Of particular interest to the assessing official is the reason for the purchase of the land.

While not controlling in the assessing official’s determination, the following factors may be of assistance:

- (1) the acreage is designated by the DNR as qualifying for one of their classified programs. The DNR has established a 10 acre minimum for its programs;

- (2) the owner can show an active timber management program in place which will improve the marketability of the forest for an eventual harvest;
- (3) the owner possesses a DNR management plan to further enhance the forest quality; and
- (4) the owner can show that regular forest harvests have occurred over a long time period.

### *Woodland Examples*

a. A seven (7) acre parcel of land that comprises a one acre home site and six acres of woods. The property owner claims that the six acres of woods should be assessed at the agricultural rate because the increase in the assessment caused by the residential “excess acreage” classification is exorbitant. The owner acknowledges that there is no timber management plan in-place. He bought the seven acre parcel because the Zoning Department requires at least five acres to construct a dwelling in a non-subdivided rural area.

*Conclusion:* Owner admits purchasing the parcel to satisfy residential use, not agricultural use. There is no evidence the land is used for an agricultural purpose. Additionally, there is no evidence of a timber management plan in-place, or past timber harvests. The parcel should be priced with the residential excess acreage rate.

b. Various wooded parcels, both large and small, within a county have been reclassified from the agricultural productivity method of calculation to a flat excess acre rate. The following are examples:

(1) An 81 acre parcel has a one acre home site, 61 acres of woods, and 20 acres of tillable land. The county classified the 61 acres of woods using an excess acreage rate. The 61 acres of wooded area is determined to be land capable of producing timber or other wood products and has 50% or more canopy cover.

*Conclusion:* The parcel’s segmented land use types should continue to be priced using the agricultural productivity method because the parcel was purchased for agricultural use and is utilized for agricultural purposes as described in the *Guidelines*. Evidence of a farm number is also a factor in the assessor’s determination.

(2) Mr. Zee recently inherited a 54 acre parcel upon the death of his grandfather. The grandfather pastured the hillside property in the 1970s but had let the pastures overgrow with vegetation for the past 30 years. The parcel has a one acre home site and 53 acres of woods. Mr. Zee, who has no affiliation with agriculture, is planning on moving his family into the dwelling but has no plans for the 53 acre woods. The property is not enrolled in a Federal Government program, there is no timber management plan in-place, the parcel is not enrolled in a classified program, nor has there ever been a timber harvest associated with the parcel. The parcel’s assessed value was



calculated using the agricultural productivity method before the 2006 trending. As a result of trending, the 53 acres of woods was priced at the residential “excess acre” rate.

*Conclusion:* The land is appropriately classified because Mr. Zee did not purchase the land with the intent to pursue agricultural activities. Additional considerations are that Mr. Zee does not have a farm number, and he has not produced evidence of a timber management program.

(3) An eight acre parcel contains a one acre home site and seven acres of woods in an exclusive residential setting. Lots are purchased and sold in this neighborhood as residential. The owner asserts that the land is properly classified as agricultural because he cuts and sells firewood. He also files a farm schedule with his Federal Income Tax claiming that he is an agricultural producer, but does not have a farm number.

*Conclusion:* Firewood alone is not evidence of agricultural activity. The assessor should examine the reasons for the purchase of the land and its current use. Evidence of a farm number, enrollment in classified forest programs, or timber harvests may be taken into consideration. In making a final determination, the assessor should outline statutory or rule reference to support the conclusion.

#### TYPE 7—OTHER FARMLAND

Land assigned to the “other farmland” land use type is categorized into subtypes. The following table describes the subtypes.

**Table 2-22. Other Farmland Subtypes**

This subtype	Indicates
Type 71	Land used for farm buildings and barn lots. This land use subtype does not include homesites. The value is determined using the appropriate soil map productivity factor and a 40% influence factor deduction.
Type 72	Land covered by a farm pond or running water. The value is determined using a productivity factor of .50 and a 40% influence factor deduction.
Type 73	2.5 contiguous acres of land designated by the U.S. Department of Agriculture as wetlands. This land use type must be verified through records obtained from the U.S. Department of Agriculture, Farm Service Agency. The value is determined using a productivity factor of .50 and a 40% influence factor deduction.

#### TYPE 8—AGRICULTURAL SUPPORT LAND

Agricultural support land is categorized into subtypes. The table below describes the subtypes.

**Table 2-23. Agricultural Support Land Subtypes**

<b>This subtype</b>	<b>Indicates</b>
Type 81	A legal ditch. The area used and occupied as part of a legal drainage ditch is considered to have no value and is deducted from the total parcel acreage. This area also includes the area adjacent to the ditch that cannot be farmed because of the need for access to the ditch.
Type 82	A public road. The right-of-way area dedicated for public roads is deducted from the total parcel acreage.
Type 83	Land on which public utility transmission towers are situated. The area of .125 (1/8) acre is deducted from the parcel acreage. The transmission line right-of-way is assessed according to the land use of the acreage and is not deducted from the parcel acreage.

**TYPE 9—HOMESITE**

One acre per dwelling on an agricultural property is classified as agricultural homesite land. The base rate for an agricultural homesite acre is a flat rate determined by the assessing official. A soil map productivity factor is *not* applied. Information about valuing an agricultural homesite is provided in the section *Valuing Residential Acreage and Agricultural Homesites*. Type 92 is a subtype of Type 9.

Type 92 indicates agricultural excess acres. This land area is presently dedicated to a non-agricultural use normally associated with the homesite. Areas containing a large manicured yard over and above the accepted one acre homesite would qualify for the agricultural excess acre designation. The agricultural excess acre rate is the same rate that is established for the residential excess acre category. These rates are determined by the assessing official.

**Using Soil Maps**

The agricultural land assessment formula values farmland, in part, based on the productivity of each parcel's soil resources. More productive land is rated higher than less productive land. Therefore, more productive land has a higher value. To evaluate and categorize land according to its productivity, measurements are calculated from detailed soil maps published by the U.S. Department of Agriculture.

Soil maps show where different soils are located within the landscape and narrative text describes the various soil characteristics. Soils are classified based on soil series and soil map units.

**Soil Series**

A soil series is a basic classification of soils. A soil series is a group of soil units that are similar according to such characteristics as:

- horizons (soil layering)

- drainage class
- water holding capacity
- organic matter content
- various other soil characteristics.

Soil series are named with names such as Miami, Crosby, Fox, and Brookston. Each soil series is formed in a type of parent material and is generally found in a particular type of location in landscapes. For example, the poorly drained Brookston series generally is found in depressions or wide, flat areas. The soil series classification system used in the United States is national in scope. Therefore, the soil categorized in a particular soil series, such as Miami, is the same across counties throughout the state.

Soil properties, such as depth, water holding capacity, and organic matter content, are used to help estimate the productivity of the soil. Because soils are naturally occurring, not all soils categorized in a particular soil series are exactly alike. When defining a soil series, a range is defined for the characteristics noted above to account for variations. However, these variations do not greatly affect the productivity of the soil.

### **Soil Map Units**

Each soil series is further subdivided into soil map units. After soil scientists identify a soil series, they further subdivide the series by identifying soil map units based on variations in:

- surface texture, such as silt loam or sandy loam
- slope class
- amount of previous erosion.

Soil scientists draw lines around each soil map unit on aerial photographs based on their best estimate of where the soil series or soil map unit changes. In reality, the change from one soil map unit to another is gradual.

### **Soil Complexes**

The amount of information that can be shown on a soil map is related to the scale of the map. Soil maps in Indiana are published at a scale of 1 : 15,840 feet or 1 : 20,000 feet. The smallest map unit delineated by a soil scientist generally is about 3 to 4 acres.

Since soil map unit locations often are smaller than 3 to 4 acres, a delineation on a soil map often consists of more than one soil unit. The soil properties of these soil map units may be similar or dissimilar. Each dissimilar component that makes up 15% or more of the delineation is identified. The soil map unit is named as a complex, such as the Miami-Xenia complex.

If a dissimilar component makes up less than 15% of the delineation, it is referred to as an inclusion and is not included in the name of the complex. Inclusions are a normal characteristic of soil maps and do not affect the usefulness of the maps for assessment purposes.

Because each component would likely have a different productivity index, the productivity index of a complex is the weighted average of the productivity indexes of its identified components. Inclusions are not considered when determining the productivity index for a delineation.

### **Understanding the Calculation of the Soil Productivity Index**

For the purpose of defining the agricultural land assessment formula, each of the approximately 2,400 soil map units in Indiana is assigned a productivity rating. This rating is based on average estimated crop yields, which in turn are based on the physical properties of the soil, such as:

- slope
- moisture holding capacity
- natural drainage class
- depth of rooting
- amount of surface soil remaining
- organic matter content
- various other soil characteristics.

Soil productivity ratings in Indiana are based on corn yield estimates. Estimated corn yields are the most convenient and reliable yield estimates since no other crop is grown on a wider range of soils or over a larger area in the state. Estimated corn yields are based on an average level of crop management and reflect a 10-year average. Estimates of corn yields for particular soil map units are tested using data collected by Purdue University and the U.S. Department of Agriculture, Natural Resource Conservation Service from field trials, yield tests, and producer experiences. An average level of crop management is assumed to account for variations in the amount of fertilizer used, time of planting, hybrid performance, and tillage systems--crop management factors that can cause yield differences. Thus, the soil productivity ratings reflect the yield differences caused by the properties of the soil, not the crop management decisions made by agricultural producers.

The productivity factor for a soil map unit is calculated by dividing the estimated 10-year average corn yield (calculated in bushels per acre) by 100. Productivity factors do not accurately predict the actual yields for a particular year since weather has a great influence on actual yields. However, you can think of the soil productivity index as a relative ranking of soil map units. The more productive the soil, the higher

the rating. The best soil in the state has a productivity factor of approximately 1.31; the poorest soil has a productivity factor of .50.

### **Valuing Strip Mined Agricultural Land**

If coal has been strip mined from agricultural land subsequent to the creation of the detailed soil map for the area, the assessor must apply a special productivity factor to that land:

- For land strip mined on or before December 31, 1977, identify the “Soil I.D.” as “SBD7” and apply a productivity factor of .75.
- For land strip mined after December 31, 1977, identify the “Soil I.D.” as “SAD7” and apply a productivity factor of .68.

### **Valuation of Oil and Gas Interests**

Oil or gas interests include, but are not limited to; royalties, overriding royalties, mineral rights, or working interests in any oil or gas located on or beneath the surface of the land.

An oil or gas interest is subject to assessment and taxation as real property annually by the assessing official. This interest is assessed to the person who owns or operates each oil or gas interest. The total assessed value of interest in oil located on or beneath the surface or of interest in gas located beneath the surface of a particular tract of land equals the product of the following:

- The average daily production of the oil;
- Three hundred and sixty-five (365); and
- One hundred percent (100%) of the posted price of oil on the assessment date

A piece of equipment is an appurtenance to the land and assessable as real property annually by the assessing official if it is incidental to and necessary for the production of oil and gas from the land covered by the oil or gas interest. Each of the appurtenances is assessed to the person who owns or operates the working interest in the oil or gas interest. This equipment includes, but is not limited to, the following: wells, pumping units, lines, treaters, separators, tanks, and secondary recovery facilities.

The assessing official must apportion the total assessed value of all interests in the oil or gas among the owners of those interests.

### **Completing the Land Data and Computations Section of the Property Record Card for Agricultural Acreage**

The valuation of agricultural land is recorded in the “Land Data and Computations” section of the property record card. Space is provided in the table to itemize areas of land categorized as Type 2 through Type 7. Each row corresponds to one area of land

based on soil map unit delineations. Acreage categorized as Type 8 or Type 9, and adjustments, are recorded in the area to the right of the table.

**Note:** If the property has more areas of land than there are rows in this section of the property record card, use an additional card (or cards) to describe those areas.

The steps for completing the property record card for agricultural acreage are grouped into the following tasks, described in the sections below:

- **Task 1**—Record information for each land area, calculate the land value for each land area, and calculate the land value for all of the land areas.
- **Task 2**—Record information about special acreage and calculate the total number of acres of farmland.
- **Task 3**—Calculate the land value of farmland.
- **Task 4**—Calculate the land value of classified land.
- **Task 5**—Calculate the total farmland/classified land value.
- **Task 6**—Calculate the land value of homesite(s) and agricultural excess acres.

### **Task 1—Determining the Land Value for the Land Areas**

In this task, you record information about each agricultural land area that is categorized as Type 2 through Type 7, and calculate the land value for the area. Each row corresponds to a land area. A land area is an area delineated on a detailed soil map and identified by its soil map unit. After you have calculated the land value for each land area, you sum these values to determine the land value for all of the land areas listed.

To record information about each land area, perform these steps:

- STEP 1** In the “Land Type” column, enter the land use type for the land area. *Table 2-24* describes the land use types. Detailed descriptions of each land use type are provided in the section *Classifying Agricultural Land into Land Use Types* in this chapter.

**Note:** Acreage classified as Type 8 (agricultural support land) or Type 9 (agricultural homesite) is not valued in this part of the “Land Data and Computations” section.

**Table 2-24. Agricultural Land Use Types**

<b>This type</b>	<b>Indicates</b>
21	Classified Forest
22	Wildlife Habitat
24	Windbreak
25	Filter Strip
4	Tillable Land
41	Tillable Land - Floods Occasionally
42	Tillable Land - Floods Severely
43	Farmed Wetlands
5	Nontillable Land
6	Woodland
71	Farm Buildings
72	Farm Pond
73	Wetlands
81	Agricultural support land: Legal Ditch
82	Agricultural support land: Public Road Right-of-Way
83	Agricultural support land: Utility Transmission Towers
9	(One-Acre) Homesite
92	Agricultural Excess Acreage

**STEP 2** In the “Soil I.D.” column, enter the letter code that identifies the soil map unit (or complex) for the land area and is found on the detailed soil survey map. Information about soil map units is provided in the section *Soil Map Units* and the section *Soil Complexes* in this chapter.

**STEP 3** In the “Measured Acreage” column, enter the area (in acres) of the land area.

**Note:** An agricultural parcel of less than 2.5 acres does not require delineation of soil types.

**STEP 4** In the “Productivity Factor” column, enter the productivity factor corresponding to the land area’s soil map unit (recorded in the “Soil I.D.” column). Information about soil productivity factors is provided in the section *Understanding the Calculation of the Soil Productivity Index* in this chapter.

**Note:** For the Type 72 (land covered with a farm, pond or running water) and the Type 73 (designated wetlands) land use types, use a productivity factor of .50 instead of the productivity factor associated with the soil map unit.

**STEP 5** In the “Base Rate” column, record the state-wide base rate established for valuing farmland soil productivity.

**STEP 6** Calculate the adjusted rate for the land area by multiplying the base rate (entered in the “Base Rate” column) by the productivity factor (entered in the “Productivity Factor” column):

$$\text{Adjusted Rate} = \text{Base Rate} \times \text{Productivity Factor}$$

Round the adjusted rate to the nearest \$1 and enter it in the “Adjusted Rate” column.

**STEP 7** Calculate the estimated value of the land area by multiplying the adjusted rate (entered in the “Adjusted Rate” column) by the measured acreage (entered in the “Measured Acreage” column):

$$\text{Estimated Value} = \text{Adjusted Rate} \times \text{Measured Acreage}$$

Round the estimated value to the nearest \$10 and enter it in the “Estimated Value” column.

**STEP 8** In the “Influence Factor” column, indicate the influence factor, if any, applicable to the land area based on its land use type. Enter a minus sign (“-”), the influence factor, and a percent sign (“%”). **Table 2-25** lists the automatic influence factor associated with each land use type.

**Table 2-25. Influence Factors for Agricultural Acreage**

For this land use type	Use this influence factor deduction
21	- 100%
22	- 100%
24	- 100%
25	- 100%
4	None
41	- 30%
42	- 50%
43	- 50%
5	- 60%
6	- 80%
71	- 40%
72	- 40%
73	- 40%



**STEP 9** *If an influence factor does **not** apply to the land area, enter the estimated value (entered in the “Estimated Value” column) in the “Land Value” column.*

*If an influence factor applies to the land area, calculate the land value for the land area by adjusting the estimated value (entered in the “Estimated Value” column) by the influence factor (entered in the “Influence Factor” column):*

$$\text{Land Value} = \text{Estimated Value} \times (1.00 - \text{Influence Factor \%})$$

Round the land value to the nearest \$10 and enter it in the “Land Value” column.

**STEP 10** Perform Step 1 through Step 8 for each land area identified for the property. If you run out of rows in the “Land Data and Computations” section of the property record card, use an additional card (or cards).

**STEP 11** *If you used **only one** property record card to describe the land areas for the property, sum the entries in the “Measured Acreage” column and enter the total in the “Measured Acreage” cell at the bottom of the column.*

*If you used **more than one** property record card to describe the land areas for the property:*

- a. On each card except Card 001, sum the entries in the “Measured Acreage” column and enter the total in the “Measured Acreage” cell at the bottom of the column.
- b. Sum the entries in the “Measured Acreage” cell of all of the property record cards except Card 001. Enter the total in the “Supplemental Card” cell at the bottom of the “Measured Acreage” column on Card 001.
- c. On Card 001, sum the entries in the “Measured Acreage” column, including the entry in the “Supplemental Card” cell. Enter the grand total in the “Measured Acreage” cell at the bottom of the column on Card 001.

**STEP 12** *If you used **only one** property record card to describe the land areas for the property, sum the entries in the “Land Value” column and enter the total in the “Land Value” cell at the bottom of the column.*

*If you used **more than one** property record card to describe the land areas for the property:*

- a. On each card except Card 001, sum the entries in the “Land Value” column and enter the total in the “Land Value” cell at the bottom of the column.
- b. Sum the entries in the “Land Value” cell of all of the property record cards except Card 001. Enter the total in the “Supplemental Card” cell at the bottom of the “Land Value” column on Card 001.
- c. On Card 001, sum the entries in the “Land Value” column, including the entry in the “Supplemental Card” cell. Enter the grand total in the “Land Value” cell at the bottom of the column on Card 001.

### **Task 2—Calculating the Total Farmland Acreage**

In this task, you record information about agricultural acreage that is categorized as Type 8 (agricultural support land) or Type 9 (agricultural homesite), and calculate the total number of acres of farmland for the property.

To record information about special agricultural acreage and to calculate the total farmland acreage, perform these steps:

**STEP 1** In the “Parcel Acreage” cell, enter the total number of acres in the parcel.

**STEP 2** In the “81 Legal Drain NV” cell, enter the number of acres categorized as Type 81 (legal ditch).

**Note:** Descriptions of the Type 8 land use types are provided in the section *Type 8—Agricultural Support Land* in this chapter.

**STEP 3** In the “82 Public Roads NV” cell, enter the number of acres categorized as Type 82 (public road right-of-way).

**STEP 4** In the “83 UT Towers NV” cell, enter the number of acres (.125 acre per tower) categorized as Type 83 (utility transmission towers).

**STEP 5** In the “Homesite (s)” cell, enter the number of acres (1 acre per dwelling) categorized as agricultural homesite acreage.

**Note:** A description of the Type 9 (agricultural homesite) land use type is provided in the section *Type 9—Homesite* in this chapter.

**STEP 6** In the “92 Agricultural Excess Acres” cell, enter the number of acres categorized as Type 92 (agricultural excess acres).

**STEP 7** Sum the acres entered in the following cells:

- “81 Legal Drain NV”
- “82 Public Roads NV”
- “83 UT Towers NV”

- “9 Homesite(s)”
- “92 Agricultural Excess Acres”.

**STEP 8** Calculate the total farmland acreage by subtracting the sum calculated in Step 7 from the parcel acreage (entered in the “Parcel Acreage” cell):

$$\text{Total Farmland Acreage} = \text{Parcel Acreage} - \text{Sum Calculated in Step 7}$$

Enter the total farmland acreage in the “Total Acres Farmland” cell.

### **Task 3—Calculating the Value of Farmland**

To calculate the value of farmland for the property, you use the measured acreage and land value calculated in Task 1 to determine the average farmland value per acre. Then you apply this average value to the total number of acres of farmland, calculated in Task 2.

To calculate the land value of farmland for the property, perform these steps:

**STEP 1** In the “Farmland Value” cell below the “Total Acres Farmland” cell, enter the land value calculated for all of the land areas in Task 1, Step 12 (entered in the “Land Value” cell at the bottom of the “Land Value” column).

**STEP 2** In the “Measured Acreage” cell, enter the total measured acreage calculated for all of the land areas in Task 1, Step 11 (entered in the “Measured Acreage” cell at the bottom of the “Measured Acreage” column).

**STEP 3** Calculate the average farmland value per acre by dividing the farmland value (entered in the “Farmland Value” cell) by the measured acreage (entered in the “Measured Acreage” cell):

$$\text{Average Farmland Value Per Acre} = \frac{\text{Farmland Value}}{\text{Measured Acreage}}$$

Round the average farmland value per acre to the nearest \$1 and enter it in the “Average Farmland Value / Acre” cell.

**STEP 4** Calculate the value of farmland acreage by multiplying the total farmland acreage (entered in the “Total Acres Farmland” cell) by the average farmland value per acre:

$$\text{Value of Farmland Acreage} = \text{Total Acres Farmland} \times \text{Average Farmland Value Per Acre}$$

Round the value of farmland acreage to the nearest \$10 and enter it in the “Value of Farmland” cell.

**Task 4—Calculating the Value of Classified Land**

To calculate the value for classified land, perform these steps:

- STEP 1** Determine the amount per acre under IC 6-1.1-6-14 for the immediately preceding assessment date (“Preceding Assessment Amount Per Acre”).
- Step 2** Calculate the classified land adjustment by multiplying the Preceding Assessment Amount Per Acre (Step 1) by one (1) plus the annual percentage change in the Consumer Price Index for All Urban Consumers published by the federal Bureau of Labor Statistics for the calendar year preceding the calendar year before the assessment date (“Annual Percentage Change”):

$$\text{Classified land value} = \frac{\text{Preceding Assessment Amount Per Acre}}{\text{Amount Per Acre}} \times (1 + \text{Annual Percentage Change})$$

Enter the value of classified land in the “Classified Land Total” cell

**Task 5—Calculating the Total Farmland/Classified Land Value**

To calculate the total farmland/classified land value for the property sum the value of farmland (entered in the “Value of Farmland” cell) and the value for classified land (entered in the “Classified Land Total” cell):

$$\text{Total Farmland/Classified Land Value} = \text{Value of Farmland} + \text{Classified Land Value}$$

Round the total farmland/classified land value to the nearest \$100 and enter it in the “Total Farmland/Classified Land Value” cell.

**Task 6—Calculating the Land Value of the Homesite(s) and Agricultural Excess Acres**

To calculate the land value of the homesite(s) and agricultural excess acres perform the following steps:

- STEP 1** Enter the value determined for all homesites on the property in the “Homesite(s) Value” cell. Information about valuing homesites is provided in the section *Valuing Residential Acreage and Agricultural Homesites* in this chapter.
- STEP 2** Enter the value determined for all agricultural excess acres on the property in the “Ag Excess Acres” cell. Information about valuing agricultural excess acres is provided in the section *Classifying Agricultural Land into Land Use Types* in this chapter.

Round the land values determined in Steps 1 and 2 to the nearest \$100.

### **Completing the Valuation Record Section of the Property Record Card**

Complete the “Valuation Record” section of the property record card, and sign and date the card on the second page, after you have valued the real property as outlined in the Manual and Guidelines.

*Figure 2-15* shows the “Valuation Record” section of the Agricultural Property Record Card.

*Figure 2-16* shows the “Valuation Record” section of the Residential Property Record Card.

*Figure 2-17* shows the “Valuation Record” section of the Commercial and Industrial Property Record Card.









IMPROVEMENT DATA AND COMPUTATIONS											
IMPROVEMENT DATA AND COMPUTATIONS										IMPROVEMENT FEATURES	
IMPROVEMENT DATA AND COMPUTATIONS										Major Items	Agricultural
IMPROVEMENT DATA AND COMPUTATIONS										Bams	T / S / L / P / E / I / D / Q
IMPROVEMENT DATA AND COMPUTATIONS										Concrete Floor	Open Side
IMPROVEMENT DATA AND COMPUTATIONS										Dirt Floor	Cementment
IMPROVEMENT DATA AND COMPUTATIONS										Electric Lights	P / C / I
IMPROVEMENT DATA AND COMPUTATIONS										Grade	Platted Floors
IMPROVEMENT DATA AND COMPUTATIONS										Heating	Plumbing
IMPROVEMENT DATA AND COMPUTATIONS										Insulation	Living Quarters
IMPROVEMENT DATA AND COMPUTATIONS										Loft	Stalls
IMPROVEMENT DATA AND COMPUTATIONS										P	Type of Construction
IMPROVEMENT DATA AND COMPUTATIONS										Q	Frame/Wire
IMPROVEMENT DATA AND COMPUTATIONS										S	Free-standing
IMPROVEMENT DATA AND COMPUTATIONS										T	Drive thru
IMPROVEMENT DATA AND COMPUTATIONS										Residential	No Roof
IMPROVEMENT DATA AND COMPUTATIONS										BOAT HOUSE	FRANARIES
IMPROVEMENT DATA AND COMPUTATIONS										T / G / D / Q	L
IMPROVEMENT DATA AND COMPUTATIONS										Open Side	Storage Bins
IMPROVEMENT DATA AND COMPUTATIONS										Cement	Pole Type
IMPROVEMENT DATA AND COMPUTATIONS										T / G / D	GRAIN BINS
IMPROVEMENT DATA AND COMPUTATIONS										Open/Enclosed	Diameter & Height or
IMPROVEMENT DATA AND COMPUTATIONS										Back-to-back	Back-to-back
IMPROVEMENT DATA AND COMPUTATIONS										Stall Walls	DRAINAGE
IMPROVEMENT DATA AND COMPUTATIONS										DRAINAGE	QUONSET BUILDING
IMPROVEMENT DATA AND COMPUTATIONS										T / G / D / L / Q	E / I / H
IMPROVEMENT DATA AND COMPUTATIONS										GREENHOUSE	Floor: Asphalt/Concrete
IMPROVEMENT DATA AND COMPUTATIONS										G	SLURRY TANKS
IMPROVEMENT DATA AND COMPUTATIONS										Free Standing	Inground/above ground
IMPROVEMENT DATA AND COMPUTATIONS										Attached at End	Round/Rectangle
IMPROVEMENT DATA AND COMPUTATIONS										STABLES	Plank Cover/No Cover
IMPROVEMENT DATA AND COMPUTATIONS										T / G / D / L	SILCO
IMPROVEMENT DATA AND COMPUTATIONS										SWIMMING POOL	Death
IMPROVEMENT DATA AND COMPUTATIONS										L	Width
IMPROVEMENT DATA AND COMPUTATIONS										Underwater Lighting	Conc. Slab/Reinfd
IMPROVEMENT DATA AND COMPUTATIONS										Tile: Ceramic/Plastic	Masonry:
IMPROVEMENT DATA AND COMPUTATIONS										Filler	Tile/Conc. Blk./Brck
IMPROVEMENT DATA AND COMPUTATIONS										Heater	Steel:
IMPROVEMENT DATA AND COMPUTATIONS										Non-rectangular Shapa	Unlined/Glass Lined
IMPROVEMENT DATA AND COMPUTATIONS										No Roof	No Roof
IMPROVEMENT DATA AND COMPUTATIONS										Enclosure Type	TENNIS COURT
IMPROVEMENT DATA AND COMPUTATIONS										TENNIS COURT	SILCO
IMPROVEMENT DATA AND COMPUTATIONS										Clay/Soil/Asphalt	UTILITY SHED
IMPROVEMENT DATA AND COMPUTATIONS										T / S	

SUMMARY OF RESIDENTIAL IMPROVEMENTS																
ID	Use	Story Height	Const. Type	Year Const.	Eff. Age	Concl.	Base Rate	Features	L / M	Adj. Rate	Size or Area	Replacement Cost	Total Dappr.	Remainder Value	% Comp	Nibbl Improvement Value
01																
02																
03																
04																
05																
06																
07																
Supplemental Card Residential Improvement Total																
Total Residential Improvement Value																

SUMMARY OF NON-RESIDENTIAL IMPROVEMENTS																
ID	Use	Story Height	Const. Type	Year Const.	Eff. Age	Concl.	Base Rate	Features	L / M	Adj. Rate	Size or Area	Replacement Cost	Total Dappr.	Remainder Value	% Comp	Nibbl Improvement Value
01																
02																
03																
04																
05																
06																
07																
Supplemental Card Non-Residential Improvement Total																
Total Non-Residential Improvement Value																



IMPROVEMENT DATA AND COMPUTATIONS

Walls		Roofing		Circle One →		1 or A		2 or B		3 or C		4 or D		5 or E	
<input type="checkbox"/> Brick	<input type="checkbox"/> Built-up	<input type="checkbox"/> Metal	<input type="checkbox"/> Slate/Tile	<input type="checkbox"/> S.F. AREA											
<input type="checkbox"/> Stone	<input type="checkbox"/> Concrete	<input type="checkbox"/> Frame or Metal	<input type="checkbox"/> Shingle	<input type="checkbox"/> Effective Perimeter											
<input type="checkbox"/> Concrete	<input type="checkbox"/> C.B. or Tile	<input type="checkbox"/> Insulation		<input type="checkbox"/> P.A.R.											
<input type="checkbox"/> Frame or Metal				<input type="checkbox"/> Number of units											
<input type="checkbox"/> C.B. or Tile				<input type="checkbox"/> Average unit size											
<input type="checkbox"/> Insulation				<input type="checkbox"/> Floor											
				<input type="checkbox"/> Basement											
				<input type="checkbox"/> 1st											
				<input type="checkbox"/> 2nd											
				<input type="checkbox"/> 3rd											
				<input type="checkbox"/> 4th											
				<input type="checkbox"/> Frame Adj. [ ± ]											
				<input type="checkbox"/> Wall Hgt. Adj. [ ± ]											
				<input type="checkbox"/> Basis Price											
				<input type="checkbox"/> B.P.A. %											
				<input type="checkbox"/> Sub-total											
				<input type="checkbox"/> Unit Finish											
				<input type="checkbox"/> Interior Finish											
				<input type="checkbox"/> Div./Ftn. Walls											
				<input type="checkbox"/> Lighting											
				<input type="checkbox"/> Heating/Air Cond.											
				<input type="checkbox"/> Sprinkler											
				<input type="checkbox"/> S.F. Price											
				<input type="checkbox"/> Area											
				<input type="checkbox"/> Sub-total											
				<input type="checkbox"/> Plumbing											
				<input type="checkbox"/> Special Features											
				<input type="checkbox"/> Exterior Features											
				<input type="checkbox"/> TOTAL BASE											
				<input type="checkbox"/> Location Multiplier											
				<input type="checkbox"/> Grade Factor											
				<input type="checkbox"/> Replacement Cost											

SUMMARY OF IMPROVEMENTS																	
ID	Use	Story/Height	Const. Type	Grade	Year Const.	Eff. Age	Concl.	Base Rate	Features	L/M	Adj. Rate	Size or Area	Replacement Cost	Nom. Depr.	Remainder Value	Obsol. Depr.	True Tax Value
01																	
02																	
03																	
04																	
05																	
06																	
07																	
08																	
09																	
10																	
11																	
12																	
13																	
Data Collector / Date													Appraiser / Date				
													Total True Tax Improvement Value				

O T E N

SPECIAL FEATURES

Description	Value
Wash Fountains	
Circular 36"	
Circular 54"	
Semi-circular 36"	
Semi-circular 54"	
Industrial Gang Sinks	
4' long, 4 man	
8' long, 8 man	
Shower - Column	
Circular, 5 per	
Semi-circular, 3 per	
Corner, 2 per	
Shower Multi-Stall	
Circular, 5 per	
Semi-circular, 3 per	
Corner, 2 per	
<b>No. Fixtures</b>	
Gang Shower Heads	
Drinking Fountains	
Refrigerated Water Coolers	
.....with Hot & Cold Water	
Emergency Shower/Eye Wash	

To complete the “Valuation Record” sections of the Agricultural, Residential, and Commercial and Industrial Property Record Cards, and to sign and date the cards, perform these steps:

**STEP 1** In the “Assessment Year” row, enter the year when the assessment is being conducted.

**STEP 2** *If the assessment is being conducted as part of a general reassessment, “Revaluation” appears in the “Reason for Change” row.*

*If the assessment is being conducted to change the valuation of the property for a particular reason, enter the reason for the change in the “Reason for Change” row.*

**STEP 3(A)** Complete the “True Tax Value” rows (*Agricultural Property Record Card*):

**a.** In the “Res Land” row, enter the amount recorded in the “Homesite(s) Value” cell from the “Land Data and Computations” section of the property record card.

**b.** In the “Res Imp” row, enter the amount recorded in the “Total Residential Improvement Value” cell from the “Summary of Residential Improvements” section of the property record card.

**c.** Carry the value determined in sub step a to the “Adj. Res Land” row, and from sub step b to the “Adj. Res Imp” row.

**d.** In the “Ag Excess Land” row, enter the amount recorded in the “92 Ag Excess Acres” cell from the “Land Data and Computations” section of the property record card.

**e.** In the “Non-Res Imp” row, enter the amount recorded in the “Total Non-Residential Improvement Value” cell from the “Summary of Non-Residential Improvements” section of the property record card.

**f.** In the “Farm/Classified Land” row, enter the amount recorded in the “Total Farmland/Classified Land Value” cell from the “Land Data and Computations” section of the property record card.

**g.** Calculate the total true tax value of the property by summing the “Adj Res Land” cell, “Adj Res Imp” cell, “Ag Excess Land” cell, “Non-Res Imp” cell, and “Farm/Classified Land cell:

**h.**

$$\begin{array}{l} \text{Total True} \\ \text{Tax Value} \end{array} = \begin{array}{l} \text{Adj. Res} \\ \text{Land} \end{array} + \begin{array}{l} \text{Adj. Res} \\ \text{Imp} \end{array} + \begin{array}{l} \text{Ag. Excess} \\ \text{Land} \end{array} + \begin{array}{l} \text{Non-Res} \\ \text{Imp} \end{array} + \begin{array}{l} \text{Farm/Classified} \\ \text{Land} \end{array}$$

- i. Enter the total true tax value, rounded to the nearest \$100, in the “Total TTV” row.

**STEP 4** Complete the “Assessed Value” rows. The assessed values are 100% of the true tax values.

- a. In the “Adj Res Land” row, enter the assessed value of the property’s adjusted residential land.
- b. In the “Adj Res Imp” row, enter the assessed value of the property’s adjusted residential improvements.
- c. In the “Ag Excess Land” row, enter the assessed value of the property’s agricultural excess acres.
- d. In the “Non-Res Imp” row, enter the assessed value of the property’s non-residential improvements.
- e. In the “Farm/Classified Land” row, enter the assessed value of the property’s farmland and classified land.
- f. Calculate the total assessed value by summing the “Adj Res Land” cell, “Adj Res Imp” cell, “Ag Excess Land” cell, “Non-Res Imp” cell, and “Farm/Classified Land” cell:

$$\text{Total AV} = \begin{array}{c} \text{Adj.} \\ \text{Res} \\ \text{Land} \end{array} + \begin{array}{c} \text{Adj.} \\ \text{Res} \\ \text{Imp} \end{array} + \begin{array}{c} \text{Ag.} \\ \text{Excess} \\ \text{Land} \end{array} + \begin{array}{c} \text{Non-Res} \\ \text{Imp} \end{array} + \begin{array}{c} \text{Farm/Classified} \\ \text{Land} \end{array}$$

Enter the total assessed value, rounded to the nearest \$100, in the “Total AV” row.

If an equalization factor is to be applied at the county level, enter (in the “Reason for Change” row) “County Equalization” in the column just to the right of the valuation being equalized. If an equalization factor is to be applied at the state level, enter (in the “Reason for Change” row) “State Equalization” in the column just to the right of the valuation being equalized. The Department of Local Government Finance will be promulgating an equalization rule, which will provide more detailed information on the application of equalization factors.

In the assessment of agricultural properties, an equalization factor would only apply to the rows “Res Land”, “Res Imp”, “Ag Excess Land”, and “Non-Res Imp”.

**STEP 3(B)** Complete the “True Tax Value” rows (*Residential Property Record Card*)

- a. In the “Res Land” row, enter the amount recorded in the “Total Residential Land Value” cell from the “Land Data and Computations” section of the property record card.
- b. In the “Res Imp” row, enter the amount recorded in the “Total Residential Improvement Value” cell from the “Summary of Residential Improvements” section of the property record card.
- c. In the “Non-Res Land” row, enter the amount recorded in the “Total Non-Residential Land Value” cell from the “Land Data and Computations” section of the property record card.
- d. In the “Non-Res Imp” row, enter the amount recorded in the “Total Non-Residential Improvement Value” cell from the “Summary of Non-Residential Improvements” section of the property record card.
- e. Calculate the total true tax value of the property by summing the “Adj Res Land” cell, “Adj Res Imp” cell, “Non-Res Land” cell, and “Non-Res Imp” cell.

$$\text{Total True Tax Value} = \begin{array}{c} \text{Adj. Res} \\ \text{Land} \end{array} + \begin{array}{c} \text{Adj. Res} \\ \text{Imp} \end{array} + \begin{array}{c} \text{Non-Res} \\ \text{Land} \end{array} + \begin{array}{c} \text{Non-Res} \\ \text{Imp} \end{array}$$

Enter the total true tax value in the “Total TTV” row.

**STEP 4(B)** Complete the “Assessed Value” rows. The assessed values are 100% of the true tax values.

- a. In the “Adj Res Land” row, enter the assessed value of the property’s adjusted residential land.
- b. In the “Adj Res Imp” row, enter the assessed value of the property’s adjusted residential improvements.
- c. In the “Non-Res Land” row, enter the assessed value of the property’s non-residential land.
- d. In the “Non-Res Imp” row, enter the assessed value of the property’s non-residential improvements.
- e. Calculate the total assessed value by summing the “Adj Res Land” cell, “Adj Res Imp” cell, “Non-Res Land” cell, and “Non-Res Imp” cell:

f.

$$\text{Total AV} = \begin{array}{c} \text{Adj. Res} \\ \text{Land} \end{array} + \begin{array}{c} \text{Adj. Res} \\ \text{Imp} \end{array} + \begin{array}{c} \text{Non-Res} \\ \text{Land} \end{array} + \begin{array}{c} \text{Non-Res} \\ \text{Imp} \end{array}$$

Enter the total assessed value in the “Total AV” row.

If an equalization factor is to be applied at the county level, enter (in the “Reason for Change” row) “County Equalization” in the column just to the right of the valuation being equalized. If an equalization factor is to be applied at the state level, enter (in the “Reason for Change” row) “State Equalization” in the column just to the right of the valuation being equalized. The Department of Local Government Finance will be promulgating an equalization rule, which will provide more detailed information on the application of equalization factors.

In the assessment of residential properties, an equalization factor would only apply to the rows “Res Land”, “Res Imp”, “Non-Res Land”, and “Non-Res Imp”.

**STEP 3(C)** Complete the “True Tax Value” rows (*Commercial and Industrial Property Record Card*):

- a. In the “Land” row, enter the amount recorded in the “Total True Tax Land Value” cell from the “Land Data and Computations” section of the property record card.
- b. In the “Improvements” row, enter the amount recorded in the “Total True Tax Improvement Value” cell from the “Summary of Improvements” section of the property record card.
- c. Calculate the total true tax value of the property by summing the true tax value of the property’s land (entered in the “Land” row) and the true tax value of the property’s improvements (entered in the “Improvements” row):

$$\text{Total True Tax Value} = \text{True Tax Value of Land} + \text{True Tax Value of Improvements}$$

- d. Enter the total true tax value in the “Total TTV” row.

**STEP 4(C)** Complete the “Assessed Value” rows. The assessed values are 100% of the true tax values.

- a. In the “Land” row, enter the assessed value of the property’s land.
- b. In the “Improvements” row, enter the assessed value of the property’s improvements.
- c. Calculate the total assessed value of the property by summing the assessed value of the property’s land (entered in the “Land” row) and the assessed value of the property’s improvements (entered in the “Improvements” row):

$$\text{Total AV} = \text{Assessed Value of Land} + \text{Assessed Value of Improvements}$$

**d.** Enter the total assessed value, rounded to the nearest \$100, in the “Total AV” row.

If an equalization factor is to be applied at the county level, enter (in the “Reason for Change” row) “County Equalization” in the column just to the right of the valuation being equalized. If an equalization factor is to be applied at the state level, enter (in the “Reason for Change” row) “State Equalization” in the column just to the right of the valuation being equalized. The Department of Local Government Finance will be promulgating an equalization rule, which will provide more detailed information on the application of equalization factors.

In the assessment of commercial and industrial properties, an equalization factor would be applicable to the “Total TTV”.

**STEP 5** In the “Data Collector/Date” cell, have the data collector sign and date the Property Record Card.

**STEP 6** In the “Appraiser/Date” cell, have the appraiser sign and date the Property Record Card.